



# F-2 Fazer User Manual

- ENGLISH

- 中文



## F-2 FAZER



© 2021 Antari Lighting and Effects Ltd.





- ENGLISH -

## Safety Information



**Please read the following safety information carefully before operating the machine. This information includes important safeguards about installation, usage, and maintenance. Pay attention to all warning labels and instructions in this manual and printed on the machine.**

If you have questions about how to operate the machine safely, please contact your local Antari dealer for help.

- Keep this device dry.
- Always connect to a grounded circuit to avoid risk of electrocution.
- Before connecting the machine to power, always check the voltage indicate on the machine matches to your local AC voltage. Do not use the machine if AC power voltage does not match.
- Disconnect the machine from AC power before servicing and when not in use.
- If the supply cord is damaged, contact your local Antari dealer for replacement.
- This product is for indoor use only! Do not expose to rain or moisture. If fluid is spilled, disconnect AC power and clean with a damp cloth. If fluid is spilled onto electronic parts, immediately unplug the machine and contact your local Antari dealer for advice.
- No user serviceable and modifiable parts inside. Never try to repair this product, an unauthorized technician may lead the machine to damage or malfunction.
- For adult use only. Children being supervised not to play with the machine. Never leave the machine running unattended.
- The machine is not to be used by persons (including children) with reduced physical, sensory or mental capabilities, or lack of experience and knowledge.
- Installed in a well ventilated area. Provide at least 50 cm space around the machine.
- Never add flammable liquid of any kind to the machine.
- Make sure there are no flammable materials close to the machine while operating.
- Only use Antari fluid. Other fluid may lead to heater clog and malfunction.

- If the machine fails to work, unplug the machine and stop operation immediately. Contact your local Antari dealer for advice.
- Before transporting the machine, make sure the fluid tank is completely drained.
- Smoke fluid may present health risks if swallowed. Do not drink smoke fluid. Store it securely. In case of eye contact or if fluid is swallowed immediately look for medical advice.

## Unpacking and Inspection

Immediately upon receiving the machine, carefully unpack the carton, check the content to ensure that all parts are present and have been received in good condition. If any parts appear damaged or mishandled from shipping, notify the shipper immediately and retain the packing material for inspection.

**What is included:**

- 1 x F-2 Fazer
- 1 x Fluid Tank
- 1 x User Manual

## Product Dimension



## Product Overview



## Setting UP

**Step 1:** Place the machine on a flat surface and in a suitably large area with at least 50 cm of open space around the machine.

**Step 2:** Fill the fluid tank with Antari approved fluid.

**Step 3:** Connect the machine to a suitably rated power supply. To determine the power requirement for the machine, refer to the label on the back of the machine.



**Always connect the machine to a protected circuit and ensure it is properly grounded to avoid risk of electrocution.**

**Step 4:** Turn on the machine and allow it to heat up. Heat up takes approximately 1.5 minutes. Once the machine has reached operating temperature, the LCD display will show “Ready to Faze”. Now the machine is ready for operation.

**Step 5:** To start making haze, locate the **Volume** button on the control panel, and press the button to start making faze.

**Step 6:** To turn-off the unit, press and hold down the **Stop** button for at least three seconds. This will immediately begin the self-cleaning and shut down process. After the purging process is complete the unit will automatically shut down and put itself in state of hibernation.

Simple press the **Volume** button to “wake” the unit and return it operational status.

## Operation

### Control Panel Operation

The machine can be operated with the onboard digital control interface located on the rear.



Button	Function
[MENU]	Scroll through setting menu
▲ [UP]/[TIMER]	Up/Activate Timer function
▼ [DOWN]/[VOLUME]	Down/Activate Volume function
[STOP]	Deactivate Timer/Volume function

### CONTROL MENU

Interval Set 999s	Set the interval from 1 to 999 seconds
Duration Set 999s	Set the duration from 1 to 999 seconds
Timer Out 100%	Set the timer output from 1 to 100%
Volume Out 100%	Set the output volume from 1 to 100%
Fan Out 100%	Set the output volume from 20 to 100%

DMX512  
Add. 511

Set the DMX address from 1 to 511

DMX Mode  
1Ch

Set the DMX mode Sync, 1Ch or 2Ch

Quick  
Start OFF

Turn On/Off run last setting function

Info  
Ver: 1.0

This menu functions details the current machine firmware.

### DMX Connector Pin Assignment

The machine provides a 3- or 5-pin XLR connector for DMX connection. The diagram below indicates pin assignment information.

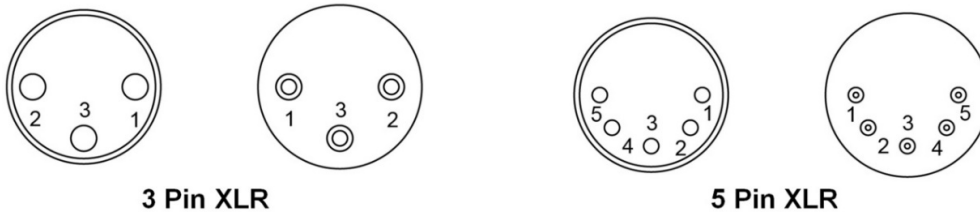

Pin	Function
1	Ground
2	Data-
3	Data+
4	N/A
5	N/A

### DMX Operation

**Making the DMX Connection** – Connect the machine to a DMX controller or to one of the machines in the DMX chain. The machine uses a 3-pin or 5-pin XLR connector for DMX connection, the connector are located on the front of the machine.



### ***DMX Channel Function***

<b>Channel Mode</b>	<b>Channel</b>	<b>Value</b>	<b>Function</b>
2	1	0-5 6-255	Faze off Faze 1-100%
	2	6-255	Fan 20-100%
1	1	0-5	Faze off Fan 100%
		6-255	Faze 1-100% Fan 100%
Sync	1	0-5	Faze Off Fan 20%
		6-255	Faze 1-100% Fan 21 – 100%

## **Fluid**

Only use Antari FLG water-based liquid for the F-2 Fazer. The machine is tested and calibrated with this liquid to get the best output performance. Warranty will be voided if any other type of liquid is used, improper use of liquid may lead to machine failure and malfunction.

## **Service and Maintenance**

- Do not allow the machine to become contaminated.
- Remove dust from the air vents with air compressor, vacuum or a soft brush.
- Only use a damp cloth to clean the casing.
- Before storing run distilled water through the system to help avoid condensing the pump or heater.
- It is recommended to run the machine on a monthly basis in order to achieve best performance and output condition.
- Excessive dust, liquid and dirt built up will degrade performance and cause overheating.



## Error Messages

Heater Overheat
--------------------

Indicates heater exceeds temperature range

Heater Error
-----------------

Indicates heater is not working properly

If above message shows on the display, unplug the machine and stop operation immediately. Contact your local Antari dealer for advice

## Technical Specifications

Input Voltage	US model: AC 100-120V, 50/60 Hz EU model: AC 220-240V, 50/60 Hz
Power Consumption	120V 1000W 240V 1500W
Warm-up Time	1.5 min. (approx.)
Max. operating time	12 hrs max. output
Fluid tank capacity	5 L
Fluid consumption	6.5 ml/min (100% output)
Compatible fluid	Antari FLG water-based fluid
Control option	DMX 512, Manual
DMX Channels	2 channels, Faze volume and fan speed
Power connection	IEC
DMX data connection	3-pin and 5-pin XLR
Dimensions	L 424.1 x W 380 x H 233.6 mm
Dry Weight:	14.7 kg



- 使用說明書 -

## 使用說明及安全注意事項



在使用機器以前，請仔細閱讀以下說明，此份說明書包含了如何在安全的情況下安裝並使用機器，且會說明機器上所有標示的標籤所代表的意義。

如果您有任何使用上的問題，請聯繫當地的 **Antari** 經銷商尋求清楚的說明與協助。

- 保持機器乾燥。
- 請配合接地型插座，以避免觸電的危險。
- 使用機器前，請確定使用場所的 AC 電源規格，與機器電壓規格是否相符。
- 拔開機器和 AC 電源插座時，請確認機器已關機不在使用的狀態下。
- 如果電源線損壞，請連繫當地的 **Antari** 經銷商尋求說明與協助。
- 本產品僅限室內使用，請勿將機器暴露在雨中或潮濕的環境，如果有液體(煙霧水)翻倒或溢出，請勿連接機器與 AC 電源，用乾布擦拭乾淨，如果任何液體進入機器電子零件，請立即拔除插頭，並聯繫當地的 **Antari** 代理商。
- 本機器不含任何用戶拆解和自行維修或修改的零件在內，請勿嘗試自行維修或改裝機器，未經授權的技術人員，可能導致機器故障或永久損壞。
- 機器限成人操作，請勿在無人值守時讓機器運作。
- 請勿讓身體、精神、感官存在缺陷或經驗不足者(包括兒童)使用本機器。
- 在通風良好的地方安裝使用機器，機器周邊至少應保留 50 公分的空間。
- 請勿添加任何易燃物品進入機器。
- 操作機器時請確認周邊沒有任何易燃的材料。
- 為確保機器的使用壽命，請使用 **Antari** 的煙霧水。使用其他品牌煙霧水可能會導致電熱管阻塞和機器的故障，並使保固失效。
- 如果機器出現故障，請拔下機器插頭，立即停止工作。並請連繫您當地的 **Antari** 經銷商。
- 運送機器以前，請確認機器的油箱已經完全清空。
- 煙霧水不能食用，吞食煙霧水可能導致損壞健康的風險，請將煙霧水存放在室內安全的地方。如果碰觸到眼睛或誤吞食，請立即尋求醫生的協助。

## 包裝內容

在收到機器後，請立即小心地打開包裝紙箱，檢查所有內容，以確保所有零配件都有齊全收到，並處於良好的狀態。如果有任何部件因運輸過程出現損壞或缺少，請立即連絡經銷商，並以原包裝退回檢查。

內容包括：  
F-2 薄煙機 1 台  
油桶 1 個  
使用說明書 1 本

## 機器尺寸



## 機器外觀概述



## 設定安裝

**步驟 1:** 將機器平放於平坦的表面，機器周圍至少應保留 50 公分的空間。

**步驟 2:** 將 FLG 煙霧水注入機器所附的油桶。

**步驟 3:** 將機器連接電源。連接之前，確認機器背後技術標籤上所標示要求功率，與電源相符。



請務必將機器連結到有保護的電路，並確保有正確地接地，以避免觸電的危險。

**步驟 4:** 啟動機器電源，使機器開始加熱。溫機到工作溫度約需時 1.5 分鐘。一旦機器到達工作溫度，LCD 控制面板會顯示“Ready to Faze”。表示機器已經準備好並進行操作。

**步驟 5:** 若欲開始輸出煙霧，請按下控制面板上的 **Volume** 按鍵。

**步驟 6:** 須關閉本機時，按住 **Stop** 按鍵約 3 秒，機器會自動進入清潔模式，待清潔完畢機器會自動關閉進入待機模式。欲喚醒機器，請按 **Volume** 按鍵，即可回到正常操作模式。

## 操作說明

### 控制面板操作

F-2 可透過機器背板上搭載的數位控制面板操作。



按鍵	功能
[MENU]	瀏覽設定清單
▲ [UP]/[TIMER]	增加/啟動 定時功能
▼ [DOWN]/[VOLUME]	減少/啟動 輸出量功能
[STOP]	關閉 定時/輸出量功能

## 操作清單

Interval Set 999s	設定每次煙霧輸出間隔，範圍是 1 至 999 秒
Duration Set 999s	設定每次煙霧輸出時間，範圍是 1 至 999 秒
Timer Out 100%	設定定時模式下的煙霧輸出量，範圍是 1 至 100 %
Volume Out 100%	設定輸出量模式下的煙霧輸出量，範圍是 1 至 100 %
Fan Out 100%	設定風扇轉速，範圍是 20 至 100%
DMX512 Add. 511	設定 DMX 位址從 1 至 511
DMX Mode 1Ch	選擇 DMX 模式： 頻道 2, 頻道 1, 與同步模式(Sync)
Quick Start OFF	開啟/關閉 使用上次設定數值的功能
Info Ver: 1.0	此選單顯示當前機器軟體版本訊息

## DMX 連接 Pin 的接點說明

本機提供 3 pin 或 5 pin XLR 的 DMX 連接選擇，以下為 Pin 的接點說明：

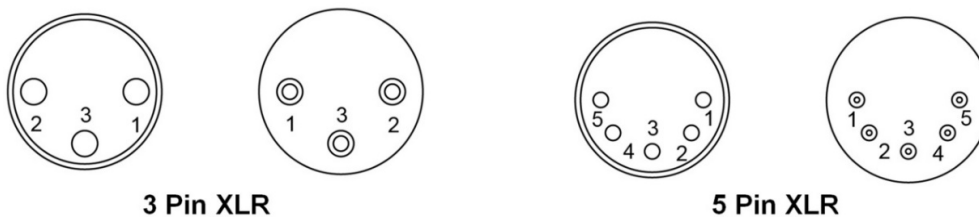

Pin	功能
1	接地
2	數據-
3	數據+
4	N/A
5	N/A

## DMX 操作

**建立 DMX 連接** – 將機器連接到 DMX 控制器或 DMX 鏈中的機器之一。本機採用的 DMX 連接座是 3-pin 或 5-pin 連接座，該連接座位於機器的正面。



## DMX 通道功能

通道模式	通道	數值範圍	功能
2	1	0-5 6-255	停止噴煙 煙霧輸出量 1-100%
	2	6-255	風扇轉速 20-100%
1	1	0-5	停止噴煙 風扇轉速 100%
		6-255	煙霧輸出量 1-100% 風扇轉速 100%
Sync	1	0-5	停止噴煙 風扇轉速 20%
		6-255	煙霧輸出量 1-100% 風扇轉速 21 – 100%

## 適用煙霧水

F-2 薄煙機，僅能使用 Antari FLG 高品質濃煙霧水。機器使用 FLG 高品質濃煙霧水進行測試與校正，使用 FLG 煙霧水將產生最佳的煙霧效果。使用其它的煙霧水，將導致機器故障並保固失效。

## 維護與保養

- 請保持機器清潔，不要讓機器髒汙。
- 可以使用空氣壓縮機，吸塵器或軟毛刷除去機器上的灰塵。
- 機殼可使用濕布擦拭。
- 存放或收起機器前，請確認機器完全冷卻，以避免幫浦或加熱管產生冷凝。
- 建議每月至少讓機器溫機並運轉一次，以保持機器處於最佳的性能和輸出條件。
- 機器上過多的灰塵，液體殘餘累積的髒污會降低機器工作性能，並導致散熱不良。

## 機器錯誤訊息

Heater Overheat	機器偵測電熱管過熱。
Heater Error	電熱管無法正常運作。

若控制面板顯示以上訊息，請立即將電源拔除並停止操作機器。請與當地 Antari 經銷商/零售商連絡，尋求協助。

## 規格資料

電壓	美規: AC 100-120V, 50/60 Hz 歐規: AC 220-240V, 50/60 Hz
額定功率	120V 1000W 240V 1500W
加熱時間	(約) 1.5 分鐘
最長運作時間	12 小時 (最大輸出量下)
油桶容量	5 L
耗油量	6.5 ml/min (100% 輸出量)
適用煙油	Antari FLG 濃煙霧水
控制方式	DMX 512, 手動控制
DMX512 頻道	占用 2 頻道, 煙霧輸出量和風扇轉速
主電源連接座	IEC
DMX 數據連接座	3-pin 及 5-pin XLR
尺寸	長 424.1 x 寬 380 x 高 233.6 mm
淨重	14.7 kg



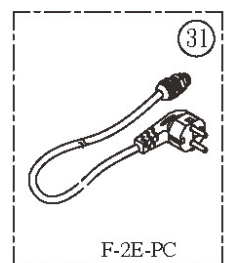
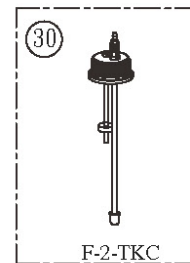
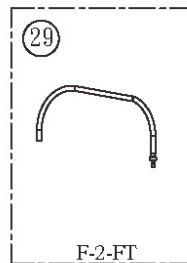
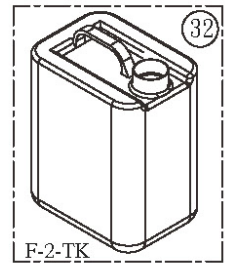
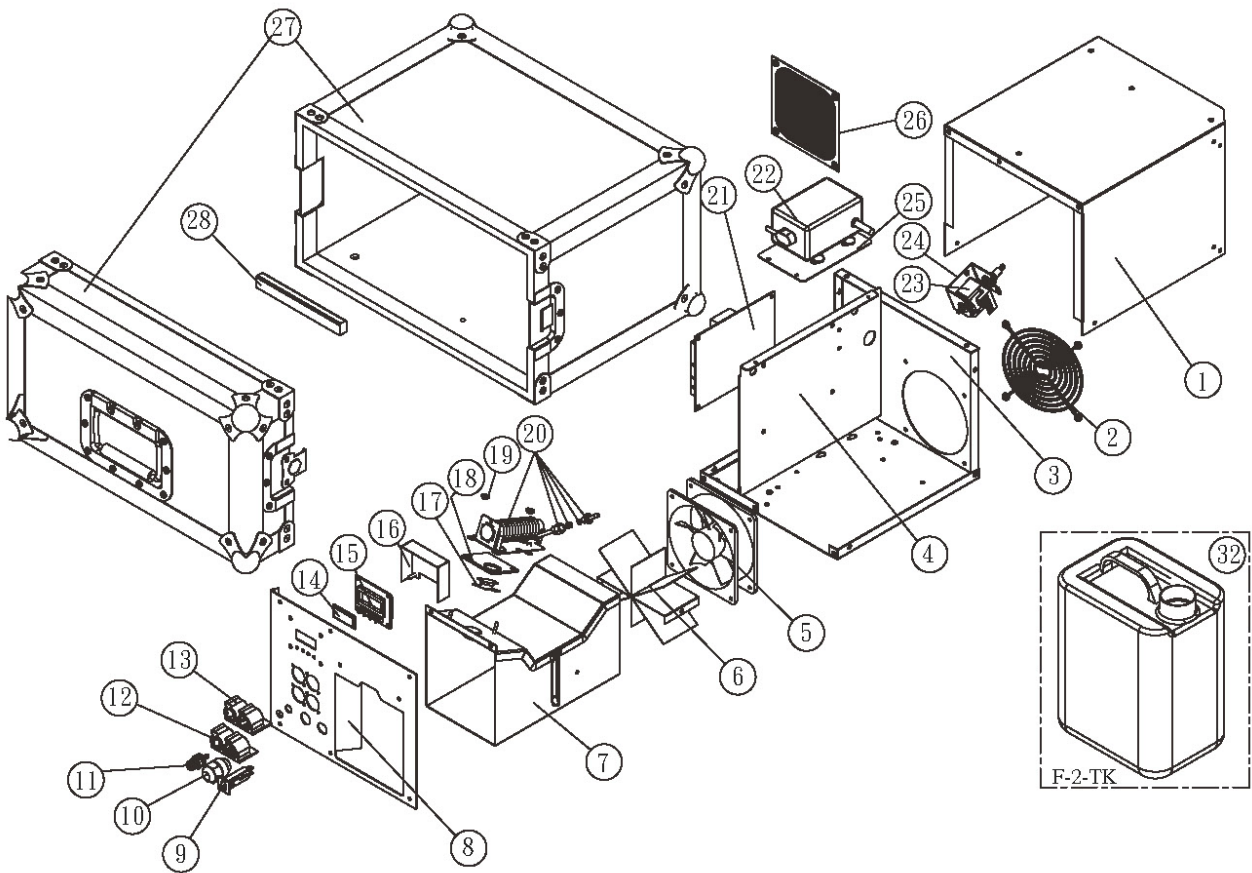

**F-2 FAZER**

- |   |                     |    |                           |
|---|---------------------|----|---------------------------|
| ① | Chassis Cover       | ①7 | Thermostat                |
| ② | Fan Guard           | ①8 | Insulation Plate          |
| ③ | Chassis Base        | ①9 | Insulation Washer         |
| ④ | Division Plate      | ②0 | Heater Set                |
| ⑤ | Fan                 | ②1 | Main PCB                  |
| ⑥ | Air Deflector       | ②2 | Air Pump                  |
| ⑦ | Air Duct            | ②3 | Pump                      |
| ⑧ | Chassis Front Plate | ②4 | Pump Mounting Bracket     |
| ⑨ | Breaker 7A 250V     | ②5 | Air Pump Mounting Plate   |
| ⑩ | Strain Relief       | ②6 | Fan Filter                |
| ⑪ | Tube Fitting        | ②7 | Flight Case               |
| ⑫ | 5 Pin DMX PCB       | ②8 | Tank Guard                |
| ⑬ | 3 Pin DMX PCB       | ②9 | Fluid tube with connector |
| ⑭ | Acrylic Plate       | ③0 | Tank Cap Set              |
| ⑮ | LCD PCB             | ③1 | Power Cord                |
| ⑯ | LCD PCB Back Cover  | ③2 | Tank                      |





**Antari**<sup>®</sup>  
FOG MACHINE

**F-2 FAZER**



C08F20001