

MAINTENANCE AND OPERATION
INSTRUCTION MANUAL

DB91-RX

Compact IP Audio Decoder



Contents

Introduction	4
Typographic conventions	5
General Information	6
Product Features	7
Technical Specifications	8
Panel Indicators and Appointments	10
<i>Front Panel</i>	10
<i>Rear Panel</i>	11
Block diagram	12
Before you start	13
<i>Safety Warning</i>	13
<i>Operating recommendations</i>	13
<i>Unpacking and inspection</i>	13
Mounting	14
<i>Heat Dissipation</i>	14
<i>Radio Frequency Interference</i>	14
Basic Setup	15
<i>Analog Audio Inputs</i>	15
<i>Digital Audio Inputs</i>	15
<i>LAN port</i>	15
WEB Interface	16
<i>Network Discovery</i>	16
<i>Access</i>	16
WEB Interface Menu pages	17
<i>Status</i>	17
<i>Settings</i>	19
<i>IP Audio</i>	20
<i>Backup</i>	21
<i>Dayparts</i>	23
<i>Output</i>	25
<i>General</i>	26
<i>Network</i>	27
<i>Network</i>	27
<i>E-mail</i>	28
<i>HTTP Server</i>	28
<i>FTP Server</i>	28
<i>SNMP Agent</i>	28
<i>Other</i>	29
<i>Firmware Update</i>	29
<i>Storage</i>	29
<i>Factory Defaults</i>	29
<i>Reboot Device</i>	29
<i>System Log</i>	30
<i>Hardware Reset</i>	31
<i>Network Default Settings</i>	31
<i>WEB Server Default Settings</i>	31
WARRANTY TERMS AND CONDITIONS	32
Product Registration Card	33
APPENDIX A	34
<i>How should I configure the connection between my DEVA Device and an FTP Client?</i>	34

THIS PAGE
IS INTENTIONALLY
LEFT BLANK

Introduction

DEVA Broadcast Ltd. is an international communications and high-technology manufacturing organization, its corporate headquarters and facility located in Burgas, Bulgaria. The company serves the broadcast and corporate markets worldwide – from consumers and small businesses to the largest global organizations. It is dedicated to the research, design, development and provision of advanced products, systems and services. DEVA launched its own brand back in 1997 and has nowadays evolved to become known as a market leader and internationally reputed manufacturer of user-friendly, cost-effective and innovative broadcast products.

Creativity and innovation are deeply woven into DEVA corporate culture. Through successful engineering, marketing and management our team of dedicated professionals creates future-oriented solutions to improve customers' performance. You may rely that all issues communicated to our crew would be addressed accordingly. We pride ourselves on our pre and post-sales support and purchase services, which along with the outstanding quality of our radio gear have won us due respect and the market authority position.

DEVA best-of-breed solutions have become the best sellers for our partners. The strategic partnerships which have been formed with industry leaders during all these years that we have been operating on the broadcasting market, have proved us a reliable business partner and a valuable asset, as our dealers worldwide would confirm. In constant pursuit of precision and long-term satisfaction, DEVA enhances the reputation of our partners and clients alike. Furthermore, we have already a proven merit as a credible partner provider.

Our portfolio offers complete line of high quality and competitive products for FM and Digital Radio, Radio Networks, Telecommunication Operators and regulation authorities. For almost two decades of intensive software and hardware development, we have achieved a unique price-performance and endurance of our product lines. Our company's multitude of equipment and services is in line with the latest technologies and key trends. The most recognizable characteristics attributed to DEVA products are their clear-cut, streamlined design, easiness of use and cost-effectiveness: simplicity of forms but multiplicity of functions.

For us there is no stage when we deem that we have reached the most satisfactory level in our work. Our engineers are in constant pursuit of new ideas and technologies to be captured in DEVA solutions. Simultaneously, a strict control is being exercised at each step of any new development. Experience and hard work are our fundament but the continuous improving process is what we never leave aside. DEVA participates on a regular basis in all landmark broadcasting events, not only to promote its products, but to exchange valuable know-how and experience. We are also engaged in international large-scale projects involving radio and audio solutions which makes us even more competitive on the global market.

All DEVA products are developed and produced in accordance with the latest ISO 9001 quality control standards.

Typographic conventions

This manual uses the following typographic conventions:

Style	Used for
NOTE	Important notes and recommendations
Example	Used when example text is cited
“Menu” on page XX.	References
[OK]	Interface Interactive buttons.
<i>Settings</i>	Menu paths are represented as follows: <i>Settings</i> > <i>General</i> > <i>Backup</i>

General Information

Implementing cutting-edge technology, along with the most widely-adopted industry standards, DEVA has designed the DB91-RX to ensure a premium broadcasting experience. This second generation IP Audio decoder supports all of the most popular compressed audio streams and PCM uncompressed audio stream. Advanced and compact, the new DB91-RX IP audio decoder comes with a built-in MP3 to enhance even more its uncompromising reliability. The real time audio encoding into a high quality configurable format process is guaranteed by the powerful DSP processor.

In continuity with the streamlined design of the renowned DB90 line, this versatile device comes in a small and compact form, enabling quick and effortless integration in the existing audio systems. The front panel's audio level bar graphs and LED indicators allow for reading at a glance the current state of the device. For easy set-up and monitoring, the DB91-RX could be managed remotely or locally through a simple and intuitive HTML5 interface and any kind of web browser, be it your PC, smart phone or tablet.

With several backup audio sources incorporated and a built-in MP3 Backup Audio Player, the DB91-RX will immediately switch between the sources when the audio is lost, and return to the main one when restored, with no user intervention. The audio content for the MP3 player is recorded on the internal SD card and the backup files can be managed remotely through the built-in FTP Server, via standard FTP client.

The DB91-RX is not only compatible with many online radio systems, Icecast and SHOUTcast included, but also supports low latency Real Time Protocol (RTP) connection. Controlled through a simple and intuitive HTML 5 based WEB Interface, the device can be used for Broadcast, Internet Radio, Studio to Transmitter Link, as well as VoIP applications. The DB91-RX IP audio decoder could be also set to work as a multicast RTP receiver, which makes it a particularly valuable asset when delivering audio to multicast groups.

Continually investing in new technology by tracking industry changes, DEVA has developed the empowering second generation compact DB91-RX IP audio decoder with the emblematic for the brand key characteristics: versatility, reliability and ease of use.

Product Features

- High Quality HE-AAC (v.1 and v.2), MPEG-1 and MPEG-3 Decoding
- 32 kHz, 44.1 and 48 kHz sample rates support
- Support of all standard bitrates and VBR as well
- IP address pronunciation at startup (through the headphones)
- DHCP Client automatically assigning Network Settings
- Easy setup via a standard web browser
- UPnP for easy discovery in Local Networks
- SHOUTcast / Icecast compatible TCP/IP client
- RTP receiver with Multicast support
- Build-in MP3 Player with Jingles Player
- Auto switching to another audio source in the event of a audio loss
- Dayparting automation support
- Analog Audio Output (2 x RCA connectors)
- Digital Audio Output (RCA Connector)
- 2 x 5 LED front panel audio level bar graphs
- 4 x Status LEDs, and Phones output for quick diagnostics

Technical Specifications

IP AUDIO CLIENT	
Type	Icecast/SHOUTcast compatible client
Count	3 independent clients
Codec Support	HE-AAC (v.1 and v.2), MPEG-1 Layer 3 or raw PCM (16-bit)
Sample rates	32 kHz, 44.1 kHz and 48 kHz
Bit Rates	All standard bitrates, including VBR
Features	HTTP redirection support
RTP AUDIO RECEIVER	
Type	RTP/UDP compatible receiver
Count	1
Codec Support	HE-AAC (v.1 and v.2), MPEG-1 Layer 3 or raw PCM (16-bit)
Sample rates	32 kHz, 44.1 kHz and 48 kHz
Bit Rates	All standard bitrates, including VBR
Features	Multicast RTP support
MP3 PLAYER	
Type	Standalone MP3 Player
Storage	microSD card
Codec Support	HE-AAC (v.1 and v.2) or MPEG-1 Layer 3
Sample rates	32 kHz, 44.1 kHz and 48 kHz
Bit Rates	All standard bitrates, including VBR
Features	Jingles auto-insertion support
Supported file types	*.MP3, *.AAC, *.M4A, *.M3U
Playback modes	Alphabetical ascending and descending, Shuffle, Playlist and Shuffled playlist
Remote file management	Build-in FTP server
AUDIO BACKUP	
Type	Silence detector with automatic backup switcher
Source	Any of the available sources; Up to 3 configurable backups
Trigger	Audio silence detector
Threshold	Adjustable, -90dBfs to 0dBfs
Trigger time	Adjustable, 1s to 240s
DAYPARTING	
Count	8 independent presets
Source	Any of the available sources
Trigger	Time and Day of the week
Duration	Adjustable, up to 24 hours

ANALOG AUDIO OUTPUT	
Connector	2 x RCA, stereo
Type	Unbalanced
Level	max. +8dBu @ 0dBFs, user configurable
Sample rate	48 kHz
Resampling	Thru build-in sample rate converter
Dynamic range	101 dB
DIGITAL AUDIO OUTPUT	
Connector	RCA
Type	S/PDIF (IEC 60958)
Sample rate	48 kHz
Resampling	Thru build-in sample rate converter
FRONT PANEL	
Level indicators	2 x 5 LED bar graphs
Status Indicators	4 LEDs
Headphones	1/8" (3.5mm) phones jack
SD Card	microSD card slot
USER INTERFACE	
Indicators	14 LEDs on front panel
Web interface	Full control and status information
Connector	RJ-45
Type	Ethernet
Device discovery	UPnP support
OPERATING CONDITIONS	
Temperature	10°C - 45°C
Humidity	< 75%, non-condensing
POWER REQUIREMENTS	
Connector	Power Jack 5.5mm
Power supply	12V DC, 1A
SIZE AND WEIGHT	
Dimensions (W;H;D)	106 x 33 x 128 mm
Shipping Weight	230 x 54 x 172 mm / 0.7kg

Panel Indicators and Appointments

FRONT PANEL

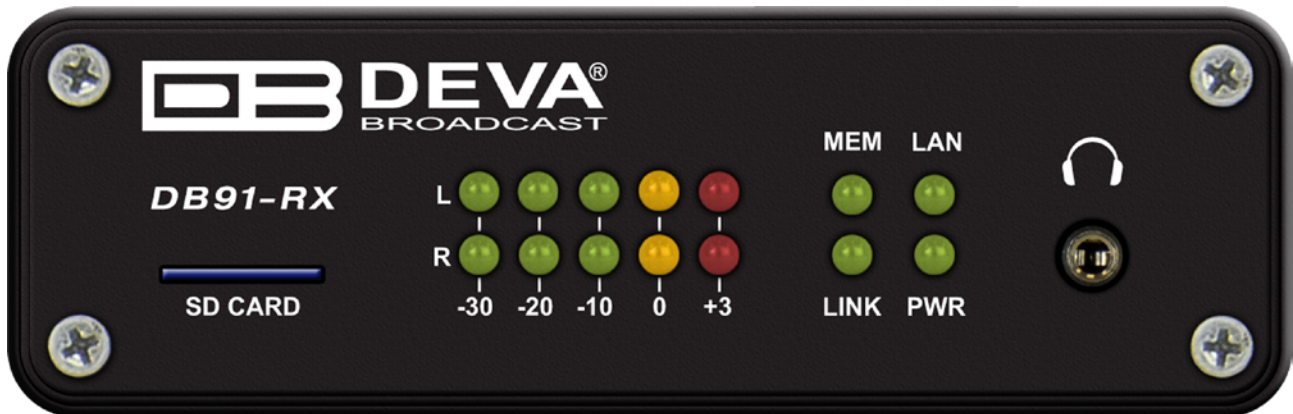

1. SD Card
2. L & R LED Meters – The full-time LED meters allow quick and easy monitoring of the Left and Right Audio channels.
3. MEM LED – microSD card status indicator.
4. LAN LED – Network status indicator
5. LINK LED – Connection status Indicator. This LED can be in one of the following states:
 - Off – NO active IP connection;
 - Blinking – at least one IP connection is active;
6. PWR LED Meter – Power LED Indicator
7. Phones Output – The following audio signals are reproduced through the headphones:
 - Voice Announcement of DB91-RX IP Audio Encoder's IP address upon startup;
 - Audio signal from the currently active audio source.

REAR PANEL



1. Power Supply (12 V, 1A);
2. Left Line Analog Output – standard RCA female jack;
3. Right Line Analog Output – standard RCA female jack;
4. Factory Defaults Reset button;
5. S/PDIF Output – standard RCA female jack;
6. LAN Port – standard RJ-45 port.

Block diagram

A simplified block diagram of DB91-RX IP Audio Encoder is shown below:

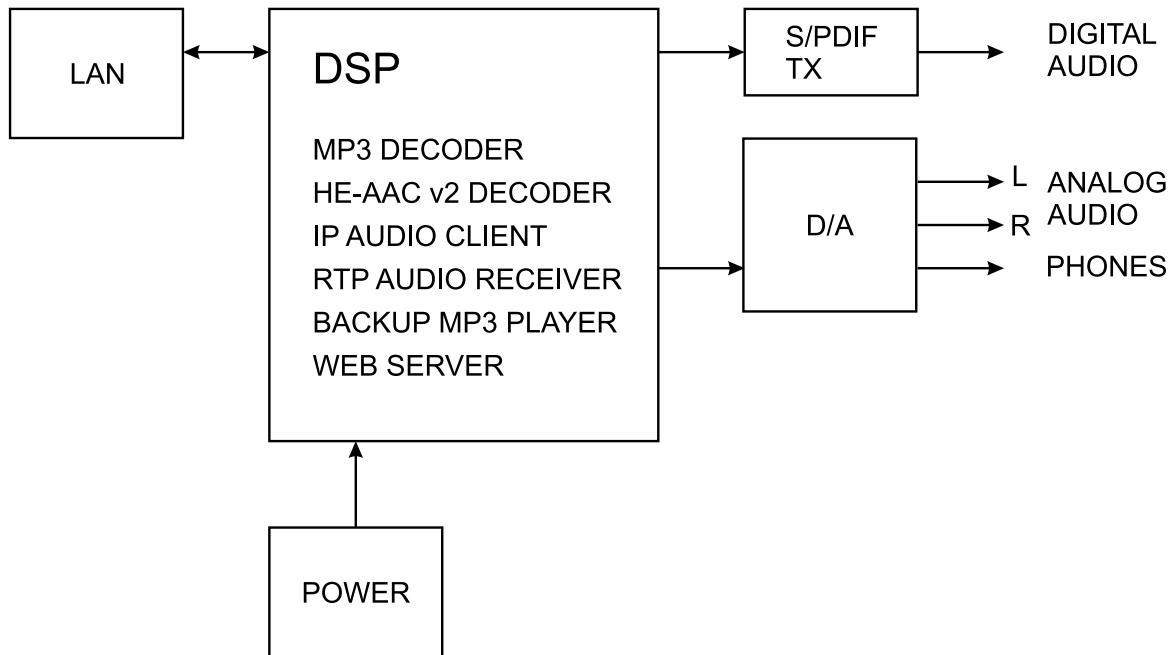

**NO USER-SERVICEABLE COMPONENTS INSIDE.
REFER ALL SERVICING TO QUALIFIED TECHNICAL PERSONNEL**

Before you start

SAFETY WARNING

- The servicing of electronic equipment should be performed only by qualified personnel;
- Before removing the covers DB91-TX must be switched off and the mains cable unplugged;
- When the equipment is open, the power supply capacitors should be discharged using a suitable resistor;
- Never touch the wires or the electrical circuits;
- Use insulated tools only;
- Never touch the metal semiconductor. They might carry high voltages;
- For removing and installing electronic components, follow the recommendations for handling MOS components.

ATTENTION: DB91-TX has an internal Lithium battery. Do not try to re-charge this battery!
Please contact us for detailed instructions in case the battery should be changed.

OPERATING RECOMMENDATIONS

For normal operation of DB91-TX, we recommend following the instructions listed below.

- Install the unit in places with good air conditioning. DB91-TX is designed to operate within the ambient temperature range of 10 to 50°C. The equipment rack should be ventilated in order for the device to keep its internal temperature below the maximum ambient temperatures;
- We do not recommend installation in rooms with high humidity, dusty places or other aggressive conditions;
- Locate the device away from abnormally high RF fields;
- Use only checked power supply cables. We strongly recommend the usage of shielded cables;
- Connect DB91-TX only to reliable power supply sources. In case of unstable power supply, please use Uninterruptible Power Supply (UPS);
- Use the device only with its top cover on to avoid electromagnetic anomalies. Otherwise, this may cause problems with the normal functionality of the unit;
- For the normal remote operation of the unit, connect DB91-TX to a good quality Internet connection;
- For the normal operation of DB91-TX, check if the network settings pass through all the required data traffic.

UNPACKING AND INSPECTION

Upon receipt, the equipment should be inspected for possible shipping damages. If such are found or suspected, notify the carrier at once and contact DEVA Broadcast Ltd. The original shipping carton box and packing materials should be kept for possible reuse, in case of return for Warranty repair, for example. Shipping damages as a result of improper packing for return may *invalidate the Warranty!*

IT IS VERY IMPORTANT that the [“Product Registration Card”](#) included in the Manual be completed accurately and returned. This will assure coverage of the terms of the Warranty and it will provide a means of trace in case of lost or stolen equipment. In addition, the user will automatically receive SERVICE OR MODIFICATION INSTRUCTIONS from DEVA Broadcast Ltd.

Mounting

HEAT DISSIPATION

Having very low electricity consumption, the DB91-TX, itself generates negligible heat. The unit is intended for operation within an ambient temperature range, extending from freezing to 120°F/50°C. But because adjacent, less efficient equipment may radiate substantial heat, be sure that the equipment rack is adequately ventilated to keep its internal temperature below the specified maximum ambient.

RADIO FREQUENCY INTERFERENCE

Although we have made provision for DB91-TX, installation in the immediate proximity of broadcast transmitters, please do practice some care using the unit near abnormally high RF fields.

Basic Setup

ANALOG AUDIO INPUTS

Using a cable ending with two standard RCA jacks connect DB91-RX analog signal outputs to the analog audio inputs of your equipment.

WARNING: Do not exceed maximum input level. This may permanently damage the device.

DIGITAL AUDIO INPUTS

Using a cable ending with a standard RCA jacks connect DB91-RX S/PDIF output to the digital audio input of your equipment.

NOTE: As only one input can be managed by the encoder at certain point of time, please select the preferred signal source input – either analog or digital one. Selecting the preferred input can be performed under CONFIGURATION menu ([see “IP Audio” on page 20](#)).

LAN PORT

For normal operation it is necessary the device to be connected to a local network or Internet by cable with RJ-45 connector.

WEB Interface

DB91-RX is controlled through a built-in WEB Server and a standard web browser can be used to monitor its status or to make some adjustments. To operate the device you need to know its IP Address. In case you are not aware of it, you can hear it through the headphones when you turn on the device. Alternatively, use the Network discovery feature at Local networks. Then open a new WEB Browser and enter the device IP address in the address field then press [Enter].

NETWORK DISCOVERY

This is a network setting that defines whether your computer can see (find) other computers and devices on the network and whether other computers on the network can see your computer. By default, Windows Firewall blocks network discovery but you can enable it.

1. Open Advanced sharing settings by clicking the Start button, and then on “Control Panel”. In the search box, type “network”, click “Network and Sharing Center”, and then, in the left pane click “Change advanced sharing settings”;
2. Select your current network profile;
3. Click Turn on network discovery, and then click save changes.

NOTE: If you’re prompted for an administrator password or confirmation, type the password, provide confirmation or contact your system administrator.

If you have already enabled this function on your computer DB91-RX will be automatically added to the Device list section. The device will be ready for usage and no additional adjustments will be required except user name and password.

ACCESS

DB91-RX provides you with a protected access to the device settings. To make the necessary adjustments to the device, please log in as an ADMINISTRATOR. The default values being username: admin, password: pass.

WEB Interface Menu pages

STATUS

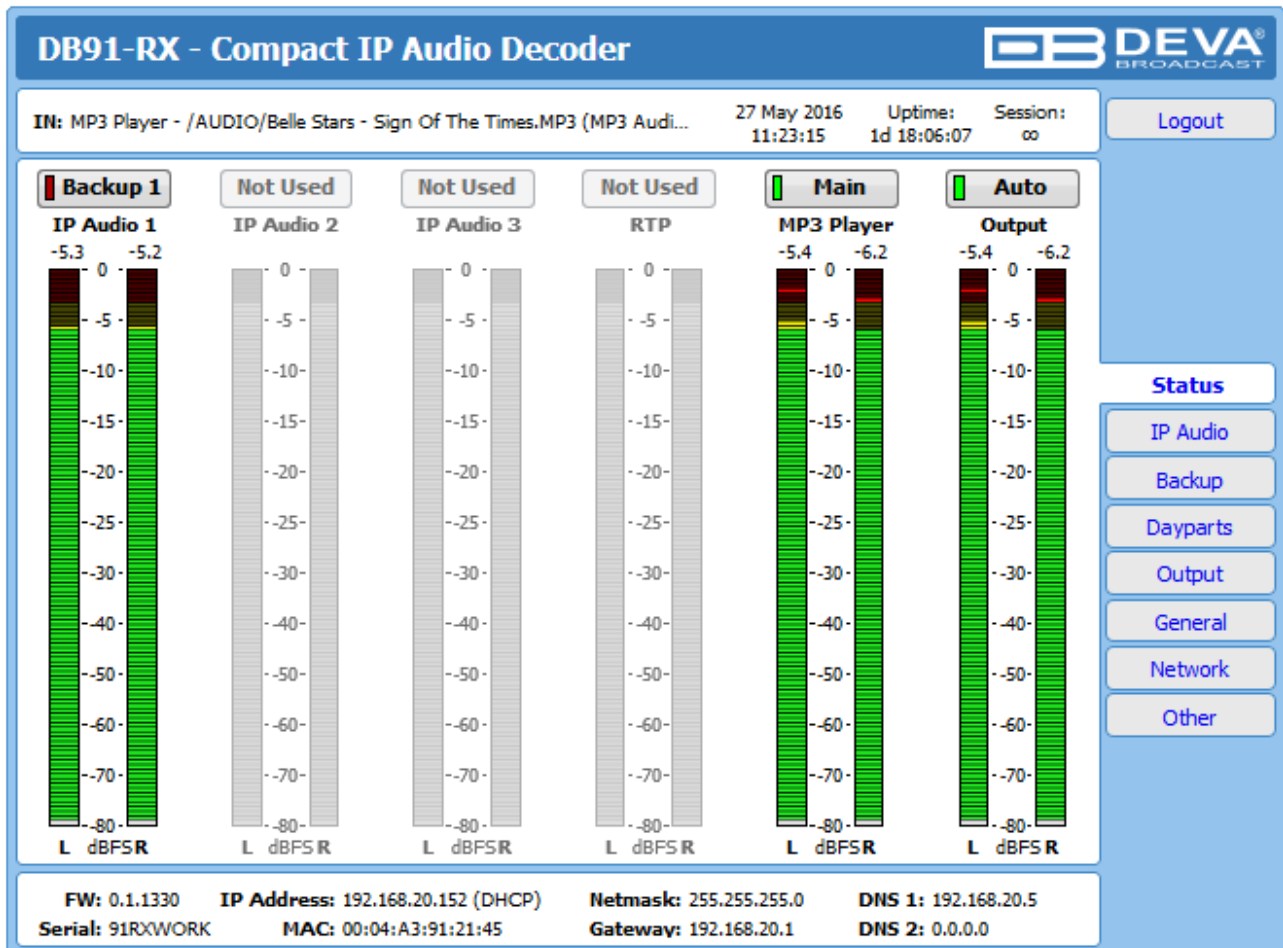

Upon opening the WEB interface, the main Status window will appear. The page contains information on the device's current status - the LED bar-graph representation of the audio sources' audio levels. The interactive buttons placed over the LED bar-graphs allow the audio source to be manually changed.

IMPORTANT NOTE: When the DB91-RX works in [Auto] mode the Backup option is working as per the set priority in the relevant section. If the source is manually changed, or Dayparting is activated, the Backup option will be deactivated, and only the selected audio source will be used. Meaning that in case of audio loss, the DB91-RX will not switch to a backup source.

At the top of the control window is placed a constant section, containing information about the input in use, Date/Time, Uptime and session timeout.

At the bottom of the control window is an information bar, gathering all the important connection parameters – firmware version in use, serial number, IP Address, and etc.

Upon change of the Web Interface screens, the main status window will resize automatically and become a constant part of each tab. Thus, allowing reading at a glance of all the mandatory parameters.

In case the Backup source is activated, you will be notified immediately via one of the possible methods (E-mail, SNMP) and with a message alerting that the backup source is on-air.

If a backup source is activated, the following message will appear on the main screen:

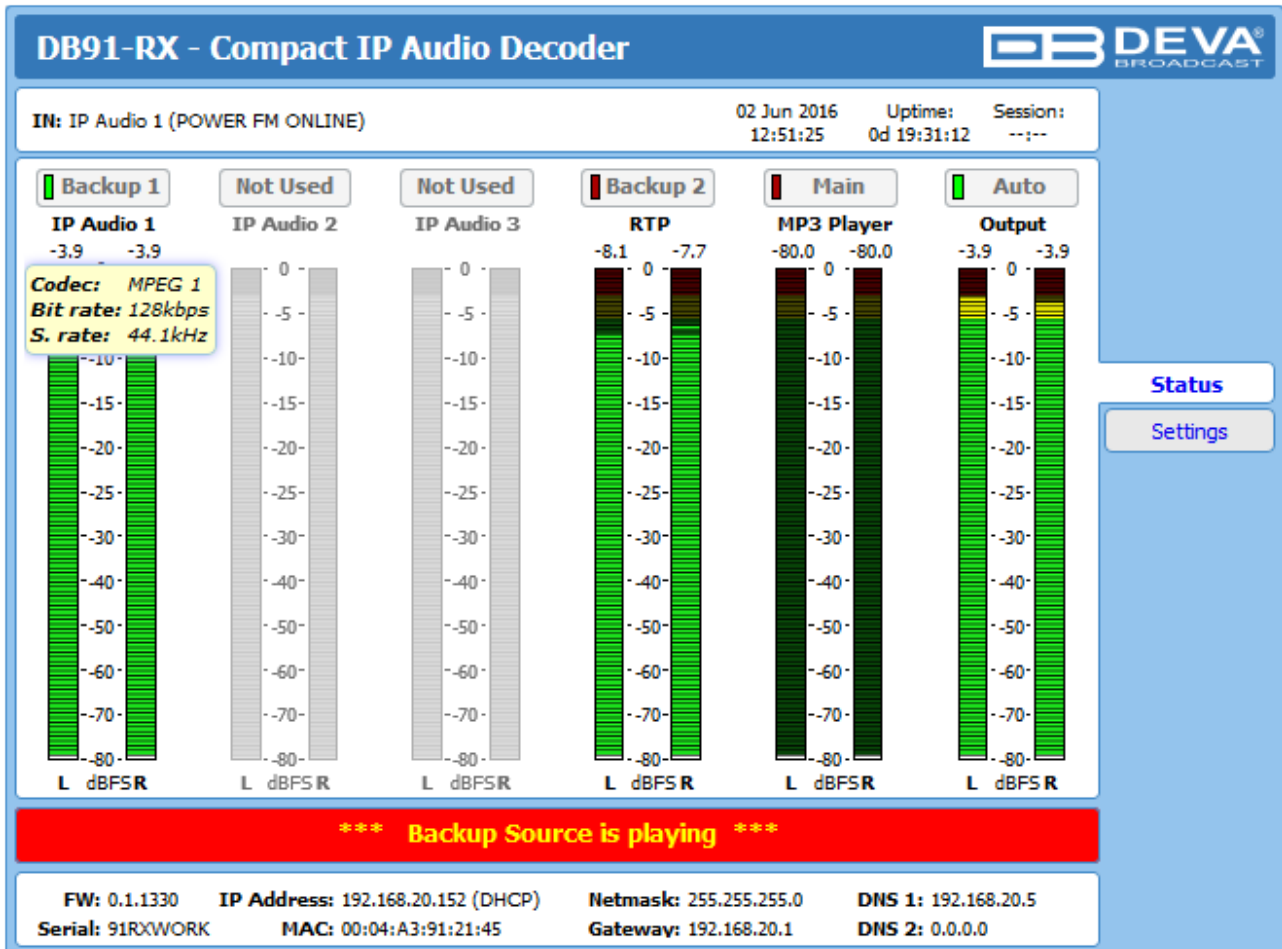

If the mouse cursor is pointed at a label of an audio source, a balloon containing information for the **Codec**, **Bit rate** and **Sample rate** will appear (as depicted above).

IP AUDIO

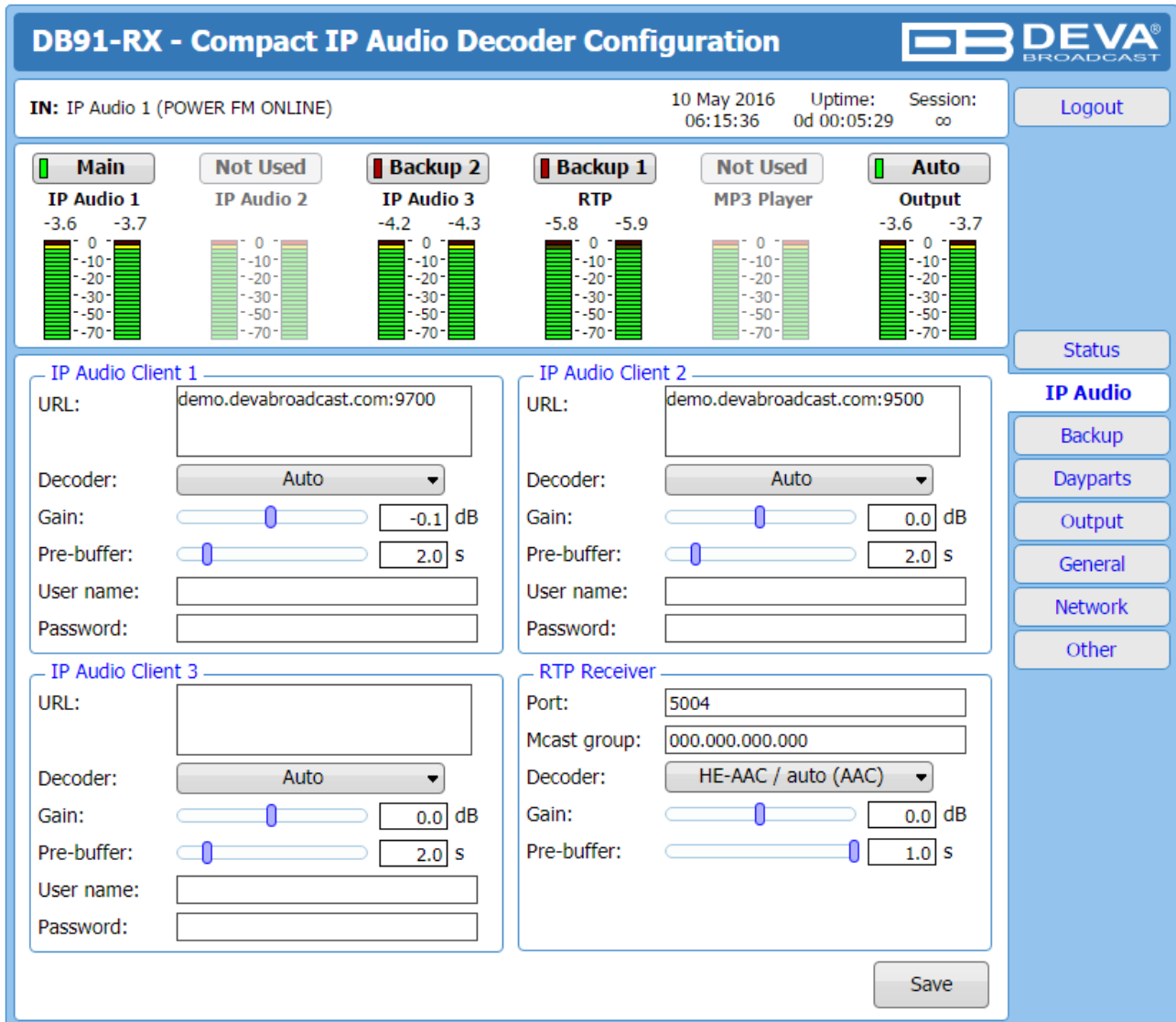

The settings applied to IP Audio Client 1, 2 and 3 are identical– Set Decoder from the drop-down menu, and URL of the stream server. Up to 63 characters can be entered.

Decoder (+ Sample rate) – Select decoder and sample rate. It can be set to Auto or manually set to a known decoder and sample rate. In Auto mode, the DB91-RX will adjust decoder and sample rate, using stream supplied information. For PCM (uncompressed) sample rate can be 32 kHz, 44.1 kHz or 48 kHz. For MPEG1 and HE-AAC the sample rate is determined automatically from the stream;

Gain – audio source gain adjustment. The Gain adjust is digital and if the sum of signal level and the Gain is greater than 0dBFS the signal will be distorted;

Pre-buffer – The minimum amount of time in which the unit will pre-buffer before playing starts in order for problems with the connection to be prevented.

NOTE: In order to ensure normal operation when PCM is used, it is necessary to select the same sample rate at both encoding and decoding side.

User name & Password – enter **User name** and **Password** if the stream server is password protected. Otherwise leave blank.

RTP Receiver – Specify *Port, Decoder, Gain, Pre-Buffer* adjustments and *Multicast group IP*.

FOR YOUR INFORMATION: A multicast address (*Mcast group*) is a logical identifier for a group of hosts in a computer network, that are available to process datagrams or frames intended to be multicasted for a designated network service.

NOTE: In order the applied settings to be used press the [Save] button, placed on the bottom right part of the screen.

BACKUP

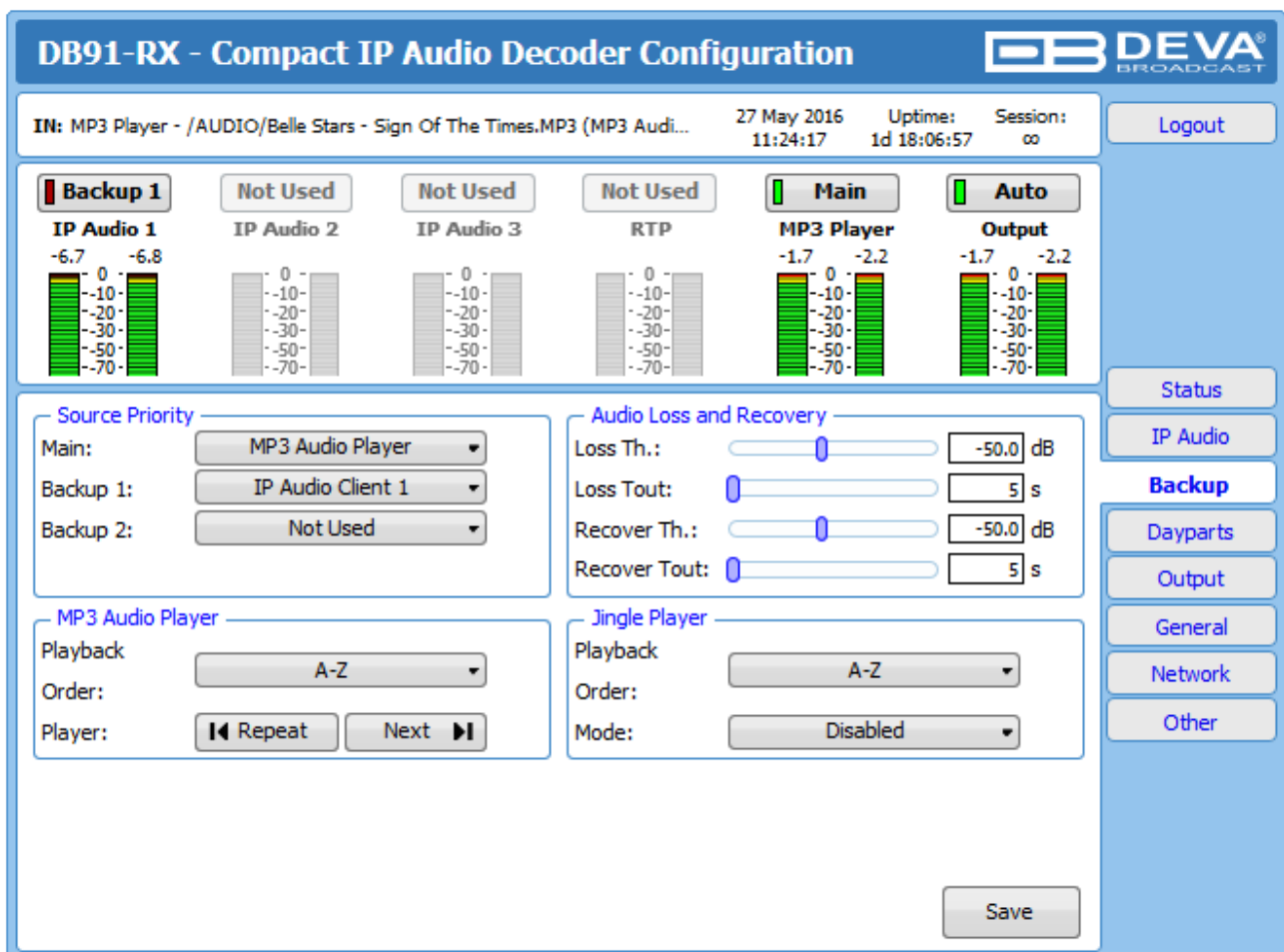

The screenshot displays the configuration interface for the DB91-RX Compact IP Audio Decoder. At the top, it shows the title 'DB91-RX - Compact IP Audio Decoder Configuration' and the DEVA BROADCAST logo. Below the title, there is a status bar with information such as 'IN: MP3 Player - /AUDIO/Belle Stars - Sign Of The Times.MP3 (MP3 Audi...', the date '27 May 2016', and uptime '1d 18:06:57'. A 'Logout' button is located in the top right corner.

The main configuration area is divided into several sections:

- Source Priority:** This section allows users to define the priority of audio sources. It includes dropdown menus for 'Main' (set to 'MP3 Audio Player'), 'Backup 1' (set to 'IP Audio Client 1'), and 'Backup 2' (set to 'Not Used').
- Audio Loss and Recovery:** This section contains sliders and input fields for 'Loss Th.' (set to -50.0 dB), 'Loss Tout' (set to 5 s), 'Recover Th.' (set to -50.0 dB), and 'Recover Tout' (set to 5 s).
- MP3 Audio Player:** This section includes a 'Playback' dropdown (set to 'A-Z'), an 'Order' dropdown, and 'Repeat' and 'Next' buttons.
- Jingle Player:** This section includes a 'Playback' dropdown (set to 'A-Z'), an 'Order' dropdown, and a 'Mode' dropdown (set to 'Disabled').

At the bottom right of the configuration area, there is a 'Save' button. On the right side of the interface, there is a vertical menu with buttons for 'Status', 'IP Audio', 'Backup', 'Dayparts', 'Output', 'General', 'Network', and 'Other'.

Through this screen are applied all needed settings to the alternative sources. The backup sources priority is user-defined and can be set through the relevant section. If the audio from the main source disappears, the DB91-RX will automatically switch to the first backup source; if it also fails, the unit will switch to the second. Once a source with higher priority is restored, the unit will switch back to it.

Audio Loss and Audio Recover – Select the appropriate levels of loss and recovery of the audio signal. Do not forget to set the corresponding timeouts.

MP3 Audio Player – The Playback Order can be changed from here. The following options are available: A-Z, Z-A, Shuffle, Playlist, and Shuffled Playlist. Information on the used and available SD card storage respectively, could also be found in this section. [Repeat] and [Next] button to navigate through the playlist if need be, are also available.

MP3 Files Upload via FTP – Through the use of a standard FTP client, you have the opportunity to update the backup content at will via any PC. The supported format is .mp3. An important requirement for the MP3 Player configuration is that all MP3 files should be stored in a folder named Audio (no sub-folders are allowed). The folder should be located in the root of the SD Card. The playlist file must be named playlist.m3u.

Jingle Player – This option is available only when the audio source is set to MP3 Audio Player. The Jingle player is designed for playing jingles (speech and music) at different intervals specified by the user. The intervals are counted by songs. From the Mode drop down menu the number of songs after which a jingle should be played is chosen. The Playback Order is also user-defined. Generally speaking, the Jingle Player allows you to make a simple radio play out.

Jingle Files Upload via FTP – Through the use of a standard FTP client, you have the opportunity to update the backup content at will via any PC. The supported format is .mp3. An important requirement is that all jingles should be stored in a folder named ‘Jingles’ (no sub-folders are allowed). The folder should be located in the root of the SD Card. The playlist file must be named playlist.m3u.

For information on how the connection between the DB91-RX and an FTP Client should be configured, please [refer to “Download files via FTP” on page 34](#).

There are eight positions at your disposal that can be set. The settings to be applied for each of them are identical:

1. Set the desired Weekday from the drop-down menu. For your convenience, the option Every day is also available;
2. Set the Start Time and Duration;
3. To finalize the setup, select the Source that should be used during this time period.

Repeat the same procedure for each of the positions that should be used.

NOTE: If the Weekday is set to Never the relative daypart will not be used. It is recommended the unused dayparts to be set to Never.

OUTPUT

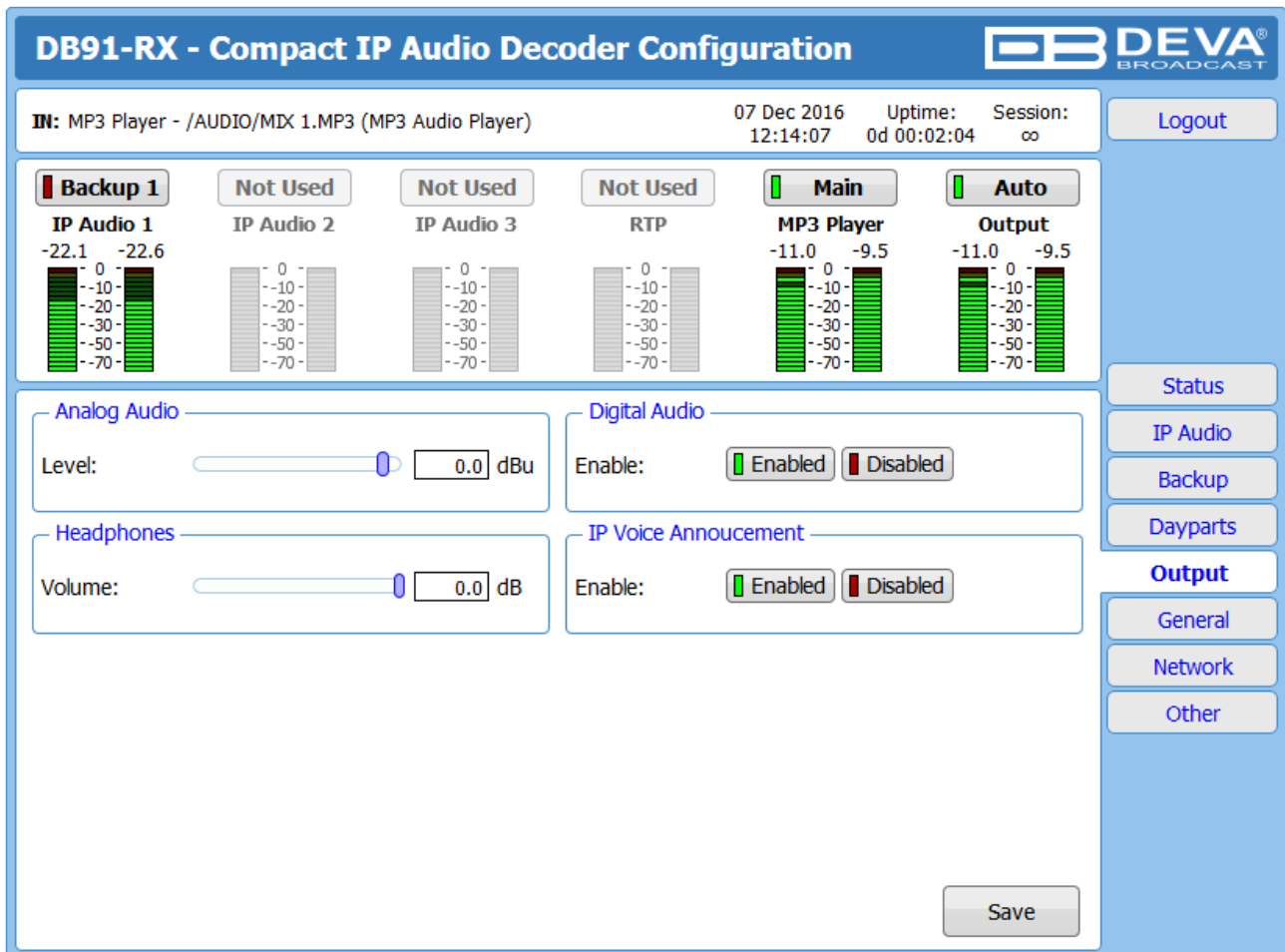

Analog Audio – set the level of the Analog Audio output (in dBu).

Digital Audio – Enable or disable the Digital Audio output.

Headphones – set the level of the Headphones output.

IP Voice Announcement - Enables or disables the IP Voice Announcement option. By default and to ease the set-up process the option is enabled. Once the set-up process is completed, it is recommended the option to be disabled. Otherwise, the IP Voice Announcement will continue to be played.

NOTE: In order the applied settings to be used press the [Save] button, placed on the bottom right part of the screen.

GENERAL

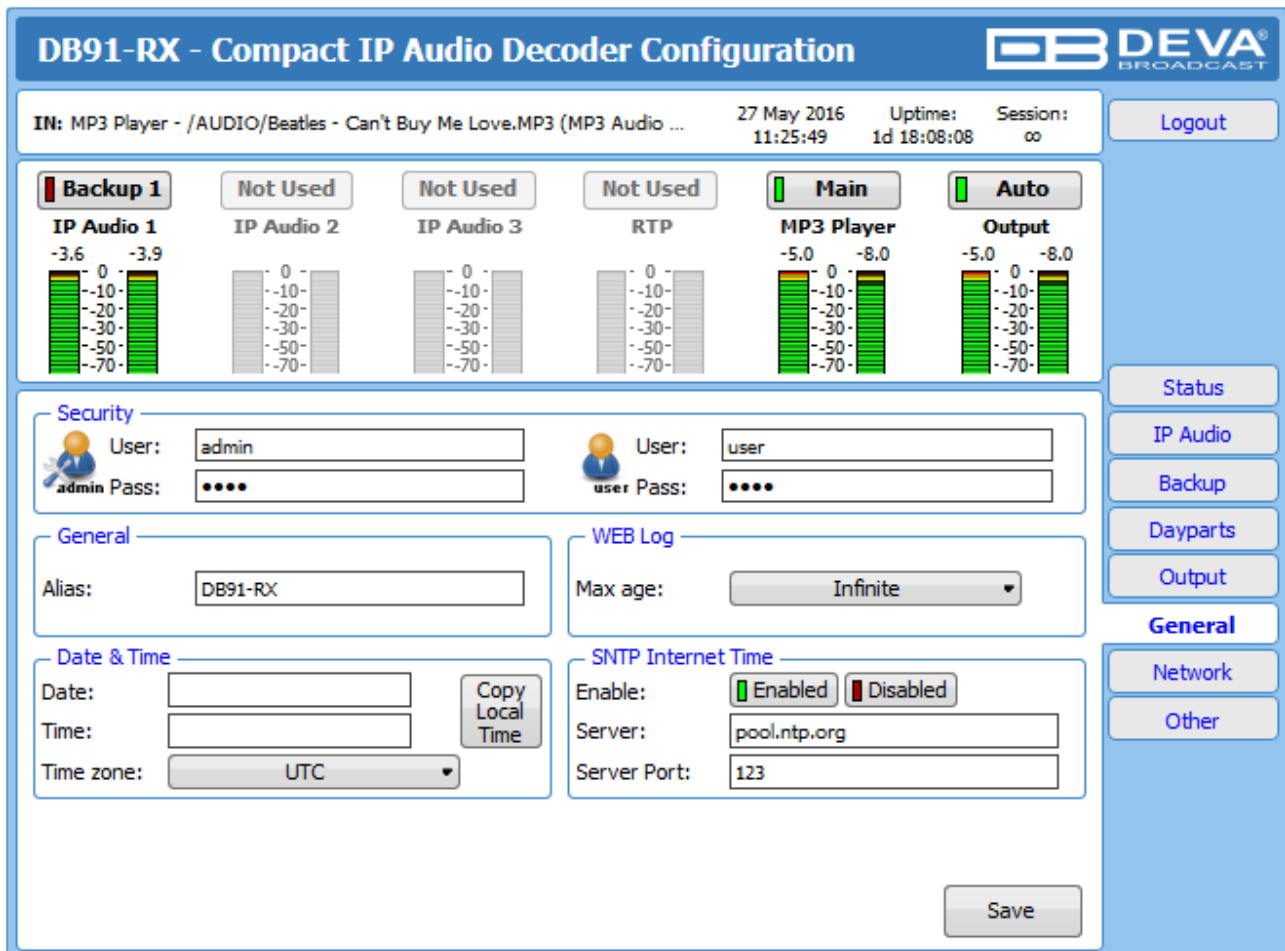

DB91-RX provides you with protected access to the device settings. You can choose between two types of log in.

- As an ADMINISTRATOR – It will give you full control over the device's settings;
- As a USER – that will allow you to just monitor the device, while all the settings remain locked.

In order for the security of DB91-RX to be enhanced, new username and password could be set from the Security section.

By choice, you can change the name of the device (*General* section). Later on, it will be used as a title name on all WEB pages. Customizing the name will make the device more recognizable.

Date & Time – used for manually determining the current Date and Time. [Copy Local Time] button will set the Date & Time to correspond to that of your computer.

SNTP Internet Time – Synchronizes automatically DB91-RX's clock time with the Internet time server. Enable this function in order to use it (Specifying the server closest to your location will improve the accuracy).

WEB Log – the maximum storage time of the log files is chosen from here. Log files older than the specified will be permanently deleted.

NOTE: In order the applied settings to be used press the [Save] button, placed on the bottom right part of the screen.

NETWORK

DB91-RX - Compact IP Audio Decoder Configuration

III: MP3 Player - /AUDIO/MX 10.MP3 (MP3 Audio Player)
07 Dec 2016 12:42:10
Uptime: 0d 00:30:08
Session: ∞
Logout

Backup 1
IP Audio 1
-21.0 -21.1

Not Used
IP Audio 2
-0 -

Not Used
IP Audio 3
-0 -

Not Used
RTP
-0 -

Main
MP3 Player
-8.2 -8.2

Auto
Output
-8.2 -8.2

Network

Enable: Enabled

DHCP: Enabled Disabled

IP Address:

Netmask:

Gateway:

Primary DNS:

Sec. DNS:

HTTP Server

Enable: Enabled

Server Port: ⚠

Session time: min

E-mail

Enable: SMTP DEVA Disabled

E-mail 1:

E-mail 2:

E-mail account:

Username:

Password:

Host name:

Connection:

Server:

Server Port:

FTP Server

Enable: Enabled Disabled

Cmd Port:

Data Port:

SNMP Agent

Agent: Enabled Disabled

Agent Port:

Agent ses. time: min

Agent ID:

Read Community:

Write Community:

Manager IP:

Manager Port:

SNMP MIB File:

⚠ - These settings require reboot.
Save
Save & Reboot

Status
IP Audio
Backup
Dayparts
Output
General
Network
Other

Network

The network addresses could be set manually (static IP) or automatically via a DHCP Server. To set static *IP*, *MASK*, *GATEWAY* and *DNS* addresses, the *DHCP* should be disabled. In order for the built-in DHCP client to be activated, the function should be enabled. When the DHCP client is activated, all assigned values will be shown in the relevant fields on the “Status Screen”. If due to any reason, the DHCP procedure cannot be completed, DB91-RX will use Auto IP and will generate an IP Address.

E-mail

Enter the desired alarm recipients in *E-mail 1* and/or *E-mail 2* fields. Fill in your e-mail account settings: *Sender*, *Username* and *Password*, *Server*, *SNMP port* and *Connection Type*.

If you experience difficulties in the set-up, or would like to use DEVA account for sending of alarm email notifications, press the [DEVA] button option, and complete the recipient emails (E-mail 1 and E-mail 2) only. The other fields must be left blank, otherwise the email notification option will not be working. Event though using the DEVA account eases the set-up process, we recommend user account to be used for sending of email notifications, and the DEVA account for test purposes. When using DEVA account, please note that the stable 24/7 connection depends on the mail service provider and cannot be guaranteed.

We recommend you to use the [Test] button and generate a test e-mail, which upon success will be delivered to the specified *E-mail 1* and/or *E-mail 2*.

Example of Test E-mail Message:

DB91-RX Test Message.

Please do not reply to this e-mail.

HTTP Server

Enable/Disable the *HTTP Server*. Specify the *Server Port* and *Session Timeout*.

FTP Server

Enable/Disable the *FTP Server*. Specify the *Command* and *Data Ports* to be used.

For information on how the connection between the DB91-RX and an FTP Client should be configured, please [refer to “Download files via FTP” on page 34](#).

SNMP Agent

Specify *Agent ID*, *Agent Port*, *Read/Write Communities*, *Manager IP*, *Manager Port* and *Agent Session Time*.

Agent – enables/disables SNMP Agent.

Agent ID – is used for identification of the device among others, when an SNMP notification is being sent.

Once all needed settings are applied, use the Test button to generate a test notification, which upon success will be received by the SNMP Manager.

Press the [Download] button to download the latest available DB91-RX SNMP MIB file.

NOTE: The MIB file may vary from one firmware revision to another. Downloading this file from the device, guarantees that you have the proper MIB file.

OTHER

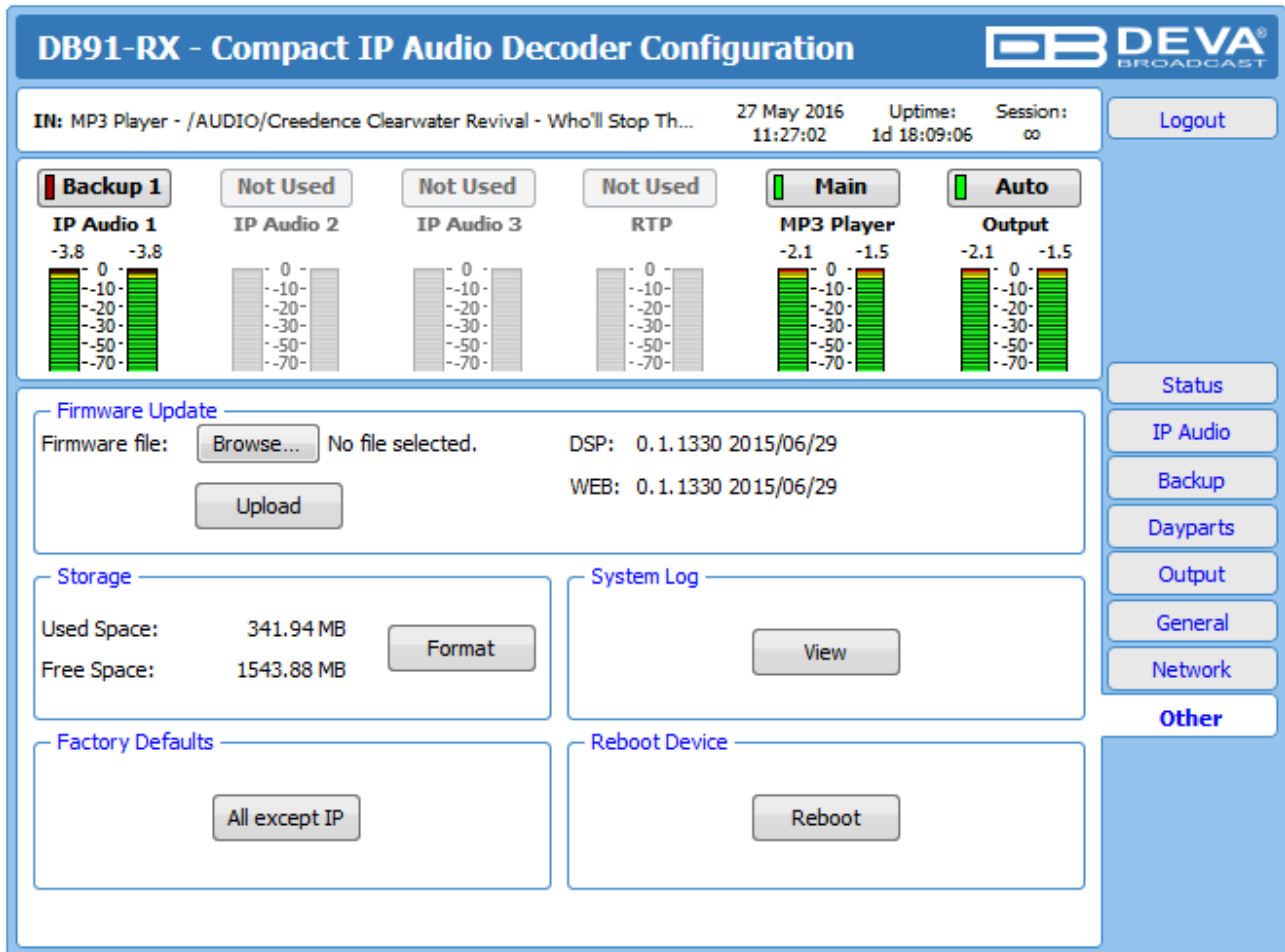

Firmware Update

To update the device firmware, press [Browse] and select the new firmware file. After having pressed the [Upload] button, a dialog window will appear. Confirm the firmware update and wait for the process to complete.

Storage

Information about the device storage space is found in this section. The internal storage could be deleted by pressing the [Format] button.

Factory Defaults

[All except IP] – all settings except for the *Network settings* (IP addresses) will be deleted.

To restore DB91-RX to its factory defaults press the button. A new window will appear - confirm that you want to restore the factory defaults and wait for the process to be completed. On completion of the process, the settings should have the proper default values.

Reboot Device

To reboot the DB91-RX, press the [Reboot] button. A dialog warning window will appear. Confirm that you want to reboot the device and wait for the process to be completed.

SYSTEM LOG

By pressing the [View] button, a window with the following options will appear:

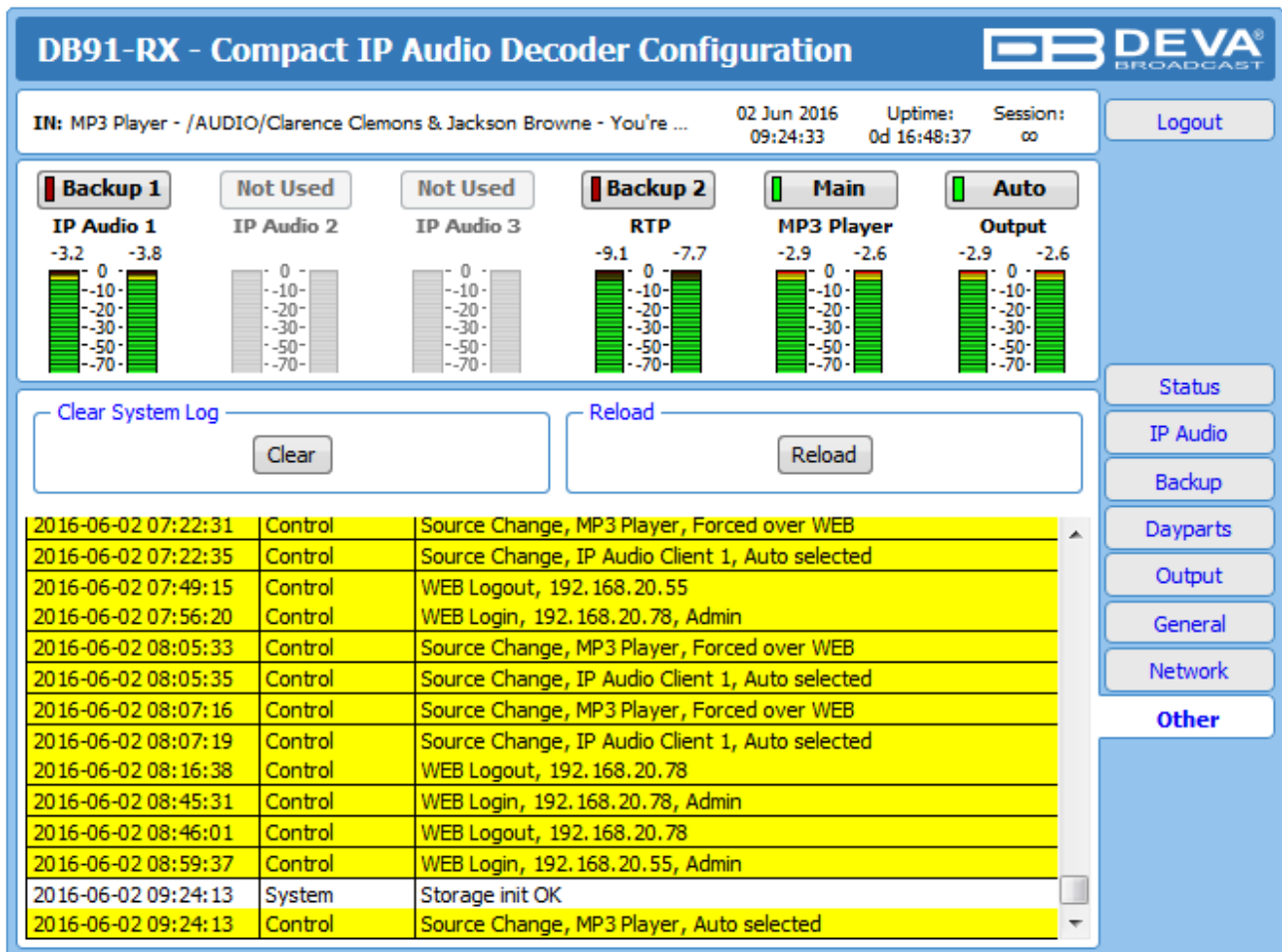

DB91-RX - Compact IP Audio Decoder Configuration

IN: MP3 Player - /AUDIO/Clarence Clemons & Jackson Browne - You're ... 02 Jun 2016 09:24:33 Uptime: 0d 16:48:37 Session: ∞

Buttons: Logout, Status, IP Audio, Backup, Dayparts, Output, General, Network, Other

Time	Type	Message
2016-06-02 07:22:31	Control	Source Change, MP3 Player, Forced over WEB
2016-06-02 07:22:35	Control	Source Change, IP Audio Client 1, Auto selected
2016-06-02 07:49:15	Control	WEB Logout, 192.168.20.55
2016-06-02 07:56:20	Control	WEB Login, 192.168.20.78, Admin
2016-06-02 08:05:33	Control	Source Change, MP3 Player, Forced over WEB
2016-06-02 08:05:35	Control	Source Change, IP Audio Client 1, Auto selected
2016-06-02 08:07:16	Control	Source Change, MP3 Player, Forced over WEB
2016-06-02 08:07:19	Control	Source Change, IP Audio Client 1, Auto selected
2016-06-02 08:16:38	Control	WEB Logout, 192.168.20.78
2016-06-02 08:45:31	Control	WEB Login, 192.168.20.78, Admin
2016-06-02 08:46:01	Control	WEB Logout, 192.168.20.78
2016-06-02 08:59:37	Control	WEB Login, 192.168.20.55, Admin
2016-06-02 09:24:13	System	Storage init OK
2016-06-02 09:24:13	Control	Source Change, MP3 Player, Auto selected

Pressing the [Clear] button will delete all recorded in the system log information.

Pressing the [Reload] button will update the displayed information.

HARDWARE RESET

This process will fully restore DB91-RX to its Factory Defaults, including the Network settings. Hardware Reset can be done by following the next steps:

1. Disconnect the power supply cable from the unit;
2. Locate the RESET button on Rear panel;
3. Press and hold the RESET button;
4. Connect the power supply cable to the unit;
5. Keep the RESET button hold until the POWER led starts blinking;
6. Release the RESET button;
7. Wait for DB91-RX to reboot.

Upon completion of the process DB91-RX settings will have the following values:

Network Default Settings

- **DHCP:** enabled

WEB Server Default Settings

- **Port:** 80
- **Username:** user
- **Password:** pass

NOTE: Upon completion of the process, the DHCP Client is enabled, and the DB91-RX will obtain IP Address from DHCP server shortly.

ATTENTION: Please note that the WEB Server's Port, Username and Password will be changed, so it is possible the page not to be loaded after restoring factory defaults. You may be asked to re-enter the encoder's address and/or username and password.

WARRANTY TERMS AND CONDITIONS

I. TERMS OF SALE: DEVA Broadcast Ltd. products are sold with an understanding of “full satisfaction”; that is, full credit or refund will be issued for products sold as new if returned to the point of purchase within 30 days following their receipt, provided that they are returned complete and in an “as received” condition.

II. CONDITIONS OF WARRANTY: The following terms apply unless amended in writing by DEVA Broadcast Ltd.

A. The Warranty Registration Card supplied with this product must be completed and returned to DEVA Broadcast Ltd. within 10 days of delivery.

B. This Warranty applies only to products sold “as new.” It is extended only to the original end-user and may not be transferred or assigned without prior written approval by DEVA Broadcast Ltd.

C. This Warranty does not apply to damage caused by improper mains settings and/or power supply.

D. This Warranty does not apply to damage caused by misuse, abuse, accident or neglect. This Warranty is voided by unauthorized attempts at repair or modification, or if the serial identification label has been removed or altered.

III. TERMS OF WARRANTY: DEVA Broadcast Ltd. products are warranted to be free from defects in materials and workmanship.

A. Any discrepancies noted within TWO YEARS of the date of delivery will be repaired free of charge, or the equipment will be replaced with a new or remanufactured product at DEVA Broadcast Ltd. option.

B. Parts and labor for factory repair required after the two-year Warranty period will be billed at prevailing prices and rates.

IV. RETURNING GOODS FOR FACTORY REPAIR:

A. Equipment will not be accepted for Warranty or other repair without a Return Authorization (RA) number issued by DEVA Broadcast Ltd. prior to its return. An RA number may be obtained by calling the factory. The number should be prominently marked on the outside of the shipping carton.

B. Equipment must be shipped prepaid to DEVA Broadcast Ltd.. Shipping charges will be reimbursed for valid Warranty claims. Damage sustained as a result of improper packing for return to the factory is not covered under terms of the Warranty and may occasion additional charges.

PRODUCT REGISTRATION CARD

- All fields are required, or warranty registration is invalid and void

Your Company Name _____

Contact _____

Address Line 1 _____

Address Line 2 _____

City _____

State/Province _____ ZIP/Postal Code _____

Country _____

E-mail _____ Phone _____ Fax _____

Which DEVA Broadcast Ltd. product did you purchase? _____

Product Serial # _____

Purchase date ____ / ____ / ____

Installation date ____ / ____ / ____

Your signature*

*Signing this warranty registration form you are stating that all the information provided to DEVA Broadcast Ltd. are truth and correct. DEVA Broadcast Ltd. declines any responsibility for the provided information that could result in an immediate loss of warranty for the above specified product(s).

Privacy statement: DEVA Broadcast Ltd. will not share the personal information you provide on this card with any other parties.

APPENDIX A

HOW SHOULD I CONFIGURE THE CONNECTION BETWEEN MY DEVA DEVICE AND AN FTP CLIENT?

In order for a connection to be established the following setting should be applied:

1. FTP Server Settings

The built-in FTP Server has four important parameters that should be configured: Command Port, Data Port, User name and Password. These parameters are to be used in the FTP client's connection configuration. Further information on how to change the FTP Server's settings and their respective default values can be found in the device's User manual.

WE RECOMMEND the usage of FileZilla (<https://filezilla-project.org>). This is a widespread open source software distributed free of charge, hence available for downloading from the Internet.

NOTE: The FTP Server can manage only one connection at a time. The FTP Server works in Passive mode. Hence, the FTP Client should also be set in passive mode.

2. IP Router and Port Translation Settings

If the connection to the device is made through a Network address translation (NAT) router or firewall, the port forwarding feature of the router should be configured. The port forwarding is usually set in the firewall section of the router's menu. As each router has different port forwarding procedure, we recommend you to refer to its complete manual. To allow proper data flow through the router, the FTP Command and FTP Data ports should be open.

NOTE: The FTP port numbers to be used in the port forwarding feature configuration can be found in the device.

3. Example of FTP Client (FileZilla) Settings

In some cases, FileZilla's "Quick connect" feature is not able to connect with the DEVA unit. That is why we recommend the device to be assigned in the program manually.

Enter the FTP Client and go to: **File > Site manager > New Site**. A dialog box requiring obligatory information about the device will appear. Fill in the needed information and press "OK".

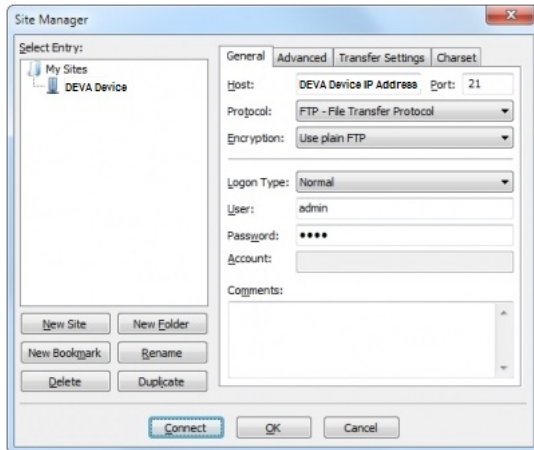

Select "Transfer Settings" sub-menu and apply the settings as shown below:

