

MAINTENANCE AND OPERATION
INSTRUCTION MANUAL

DB9009-RX

Second Generation Advanced IP Audio Decoder
with
Stereo & RDS Encoder Module



Contents

Introduction	6
Typographic conventions	7
General Information	8
Product Features	9
<i>Technical Specifications</i>	10
Panel Indicators and Appointments	12
<i>Front Panel</i>	12
<i>Rear Panel</i>	13
<i>GPIO Connectors Pinouts</i>	14
<i>GPI Port Pinouts</i>	14
<i>GPI 1 Example Connection</i>	14
<i>RS-232 Port Pinouts</i>	14
<i>Block diagram</i>	15
Safety Precautions	16
Before you start	17
<i>Safety warning</i>	17
<i>Operating recommendations</i>	17
Unpacking and Inspection	18
Mounting	19
<i>Rack equipment</i>	19
<i>Heat Dissipation</i>	19
<i>Radio Frequency Interference</i>	19
Basic Setup	20
<i>Analog Audio Outputs</i>	20
<i>Digital Audio Output</i>	20
<i>LAN Port</i>	20
<i>RS-232 COM Port</i>	20
<i>GPI port</i>	20
Front Panel - OLED Display, Navigational & Soft Buttons	21
<i>Display</i>	21
<i>Header Area</i>	21
<i>Soft buttons</i>	22
<i>Main screen working area</i>	22
Operating Modes and Pages	23
<i>Home Page</i>	23
<i>Main audio source</i>	23
<i>Backup 1</i>	23
<i>Backup 2</i>	23
<i>Graphs page</i>	24
<i>Levels page</i>	28
<i>Settings page</i>	29
<i>Settings menu title</i>	29
<i>Navigation area</i>	29
<i>Numerical parameter (INT). Represents numerical value.</i>	31
<i>Enumerated parameter (ENUM).</i>	31

<i>IP address (IP). Represents IPv4 address.....</i>	32
<i>IP port (PORT). Represents IP port.....</i>	32
<i>String (STR). Represents string.....</i>	33
<i>Date (DATE). Represent date information.</i>	33
<i>Time (TIME). Represent time information.....</i>	34
<i>Timer (TIMER). Represents relative time interval.....</i>	34
<i>Status page</i>	35
<i>About page</i>	35
WEB Interface.....	36
<i>Network Discovery.....</i>	36
<i>Access.....</i>	36
WEB Interface Menu pages	37
<i>Status</i>	37
<i>Settings</i>	38
<i>IP Audio.....</i>	39
<i>Backup.....</i>	40
<i>How can a playlist file be made?.....</i>	41
<i>Dayparts.....</i>	42
<i>MPX.....</i>	43
<i>Basic RDS.....</i>	45
<i>Dynamic RDS.....</i>	47
<i>Radio Text</i>	48
<i>PTYN (Program Type Name Settings)</i>	48
<i>Date & Time Settings</i>	48
<i>Console Settings.....</i>	48
<i>How to connect to the RDS Console</i>	49
<i>RDS Console syntax</i>	49
<i>List of available RDS console commands and their responses</i>	50
<i>Output.....</i>	51
<i>General.....</i>	52
<i>Network.....</i>	53
<i>Network.....</i>	53
<i>E-mail</i>	53
<i>HTTP Server</i>	54
<i>FTP Server.....</i>	54
<i>SNMP Agent.....</i>	54
<i>GPIO</i>	55
<i>Other</i>	56
<i>Firmware Update</i>	56
<i>Storage</i>	56
<i>System Log</i>	56
<i>Factory Defaults</i>	56
<i>Reboot Device.....</i>	56

WARRANTY TERMS AND CONDITIONS.....	57
Product Registration Card.....	58
APPENDIX A.....	59
<i>RDS: Europe vs America</i>	<i>59</i>
<i>The RDS System</i>	<i>59</i>
APPENDIX B.....	60
<i>How should I configure the connection between my DEVA Device and an FTP Client?</i>	<i>60</i>
1. <i>FTP Server Settings</i>	<i>60</i>
2. <i>IP Router and Port Translation Settings.....</i>	<i>60</i>
3. <i>Example of FTP Client (FileZilla) Settings</i>	<i>61</i>
APPENDIX C.1.....	62
<i>PTY Code Description Used in RBDS Mode – North America.....</i>	<i>62</i>
APPENDIX C.2.....	63
<i>PTY Code Description Used in RDS Mode – Europe, Asia</i>	<i>63</i>

THIS PAGE
IS INTENTIONALLY
LEFT BLANK

Introduction

DEVA Broadcast Ltd. is an international communications and high-technology manufacturing organization, its corporate headquarters and facility located in Burgas, Bulgaria. The company serves the broadcast and corporate markets worldwide – from consumers and small businesses to the largest global organizations. It is dedicated to the research, design, development and provision of advanced products, systems and services. DEVA launched its own brand back in 1997 and has nowadays evolved to become known as a market leader and internationally reputed manufacturer of user-friendly, cost-effective and innovative broadcast products.

Creativity and innovation are deeply woven into DEVA corporate culture. Through successful engineering, marketing and management our team of dedicated professionals creates future-oriented solutions to improve customers' performance. You may rely that all issues communicated to our crew would be addressed accordingly. We pride ourselves on our pre and post-sales support and purchase services, which along with the outstanding quality of our radio gear have won us due respect and the market authority position.

DEVA best-of-breed solutions have become the best sellers for our partners. The strategic partnerships which have been formed with industry leaders during all these years that we have been operating on the broadcasting market, have proved us a reliable business partner and a valuable asset, as our dealers worldwide would confirm. In constant pursuit of precision and long-term satisfaction, DEVA enhances the reputation of our partners and clients alike. Furthermore, we have already a proven merit as a credible partner provider.

Our portfolio offers complete line of high quality and competitive products for FM and Digital Radio, Radio Networks, Telecommunication Operators and regulation authorities. For almost two decades of intensive software and hardware development, we have achieved a unique price-performance and endurance of our product lines. Our company's multitude of equipment and services is in line with the latest technologies and key trends. The most recognizable characteristics attributed to DEVA products are their clear-cut, streamlined design, easiness of use and cost-effectiveness: simplicity of forms but multiplicity of functions.

For us there is no stage when we deem that we have reached the most satisfactory level in our work. Our engineers are in constant pursuit of new ideas and technologies to be captured in DEVA solutions. Simultaneously, a strict control is being exercised at each step of any new development. Experience and hard work are our fundament but the continuous improving process is what we never leave aside. DEVA participates on a regular basis in all landmark broadcasting events, not only to promote its products, but to exchange valuable know-how and experience. We are also engaged in international large-scale projects involving radio and audio solutions which makes us even more competitive on the global market.

All DEVA products are developed and produced in accordance with the latest ISO 9001 quality control standards.

Typographic conventions

This manual uses the following typographic conventions:

Style	Used for
NOTE	Important notes and recommendations
Example	Used when example text is cited
“Menu” on page XX.	References
[OK]	Interface Interactive buttons.
<i>Settings</i>	Menu paths are represented as follows: <i>Settings</i> > <i>General</i> > <i>Backup</i>

General Information

DB9009-RX is our second generation Advanced IP Audio Decoder. This new addition to DEVA Broadcasting Tools is affordable, easy to use and furnishes more features than ever before.

The powerful DSP processor allows accomplishing of the decoding process in real time. Supporting all the mandatory for this high class equipment HE-AAC versions 1 and 2, MPEG-1 Layer 3 compressed audio streams and lossless uncompressed PCM stream, the DB9009-RX can be used for a wide range of professional audio applications: Broadcast, Internet Radio, Studio to Transmitter Link and VoIP.

For an additional charge, this sophisticated device is also available in a version with a fully digital, DSP-based Stereo & RDS Encoder Module. The Encoder Module utilizes 2(or 3) outputs. The first one is for the MPX and the second for the RDS or Pilot. Through the RS-232 port, this device could be easily transformed from an Ethernet to a serial Redirector, enabling quick integration of the existing audio systems to the Internet.

This cost effective, yet highly professional device impresses with its new custom made laser cut aluminum sheet case, OLED Graphical Display and Intuitive Navigation Menu. The easy-to-read display and navigation menu allow easy status monitoring of the audio levels (visualized in bar graphs), connection information and configuration. The Soft Buttons indicators placed on the bottom side of the OLED display are used for navigation through the menus, quick access to the parameters, modes, functions and for altering of their values.

Utilizing several types of Backup sources, DB9009-RX will immediately switch between the sources (IP Audio Client, RTP, MP3 Player) and return to the main one, with no user intervention when the audio is restored. The current audio source can also be selected using one of the General Purpose Inputs. Depending on your needs, the sequence of the backup audio sources can be easily changed. The audio content for the MP3 player is recorded on the internal SD card. The backup files can be managed remotely through the built-in FTP Server, using any FTP client.

Yet another impressive addition to DB9009-RX features is the low latency Real Time Protocol (RTP) connection support. Fully compatible with any online radio system, including the Icecast and Shoutcast, this affordable device is the perfect sound solution for long distance audio transfer, for both wired and wireless networks.

Providing top-quality signal over public IP networks and even connections behind NATs and Firewalls, DB9009-RX delivers undeviating audio unaffected by the non-persistent network conditions and without the need of user interference.

Product Features

- Excellent Audio Performances
- Easy to read OLED Graphical Display
- Intuitive Navigation Menu
- High Quality HE-AAC (v.1 and v.2) and MPEG-1 Layer 3 Codecs
- 32 kHz, 44.1 and 48 kHz sample rates support
- Support of all standard bitrates and VBR as well
- Shoutcast / Icecast compatible TCP/IP stream client
- RTP Audio compatible
- Auto switching to another source in the event of a connection or audio loss
- Built-in Backup Audio Player with SD Card
- 5 LEDs and Phones output for quick diagnostics
- IP address pronunciation at startup (through the headphones)
- 3 General Purpose Inputs
- Ethernet to RS-232 redirector
- Full Control and easy setup with any web browser
- Configuration and Monitoring via SNMP Ver.2C
- UPnP for easy discovery in Local Networks

Additional features if Stereo & RDS/RBDS Encoder Module added:

- Built-in Stereo MPX Generator and RDS Encoder
- Fully Digital 32 bits DSP Stereo Encoder
- Adjustable Pilot, L-R, RDS phases
- Built-in MPX Limiter
- Selectable pre-emphasis 0, 50 μ s, 75 μ s
- Digital stereo encoder with pre-emphasis, AGC and equalizer
- Digitally adjustable Pilot & RDS injection levels
- Fully Digital Synthesis of the RDS Signal
- Fully Dynamic RDS encoder
- 1x MPX and 1x RDS/PILOT Output

TECHNICAL SPECIFICATIONS

IP AUDIO CLIENT	
Type	Icccast/SHOUTcast compatible client
Count	3 independent clients
Codec Support	HE-AAC (v.1 and v.2), MPEG-1 Layer 3 or raw PCM (16-bit)
Sample rates	32 kHz, 44.1 kHz and 48 kHz
Bit Rates	All standard bitrates, including VBR
Features	HTTP redirection support
RTP AUDIO RECEIVER	
Type	RTP/UDP compatible receiver
Count	1
Codec Support	HE-AAC (v.1 and v.2), MPEG-1 Layer 3 or raw PCM (16-bit)
Sample rates	32 kHz, 44.1 kHz and 48 kHz
Bit Rates	All standard bitrates, including VBR
Features	Multicast RTP support
MP3 PLAYER	
Type	Standalone MP3 Player
Storage	microSD card up to 16GB
Codec Support	HE-AAC (v.1 and v.2) or MPEG-1 Layer 3
Sample rates	32 kHz, 44.1 kHz and 48 kHz
Bit Rates	All standard bitrates, including VBR
Features	Jingles auto-insertion support
Supported file types	*.MP3, *.AAC, *.M4A, *.M3U
Playback modes	Alphabetical ascending & descending, Shuffle, Playlist & Shuffled playlist
Remote file management	Build-in FTP server
AUDIO BACKUP	
Type	Silence detector with automatic backup switcher
Source	Any of the available sources; Up to 3 configurable backups
Trigger	Audio silence detector
Threshold	Adjustable, -90dBFs to 0dBFs
Trigger time	Adjustable, 1s to 240s
DAYPARTING	
Count	8 independent presets
Source	Any of the available sources
Trigger	Time and Day of the week
Duration	Adjustable, up to 24 hours
ANALOG AUDIO OUTPUT	
Connector	2 x XLR, stereo
Type	Balanced
Level	max. +18dBu @ 0dBFs, user configurable
Distortion	<0.01% THD+N
Sample rate	48 kHz

Resampling	Thru build-in sample rate converter
Dynamic range	101 dB
DIGITAL AUDIO OUTPUT	
Connector	XLR
Type	AES/EBU
Sample rate	48 kHz
Resampling	Thru build-in sample rate converter
STEREO & RDS GENERATOR (OPTION)	
Mode	Mono, Stereo
Pre-emphasis	Flat, 50µs, 75µs
Pilot	0 to 15% injection level
RDS	Built-in RDS encoder
Dynamic RDS	Yes, TCP remote control
MPX OUTPUT (OPTION)	
Connector	2 x BNC
Type	Unbalanced
Level	max. +12dBu @ 100% modulation
RDS OUTPUT (OPTION)	
Connector	BNC
Type	Unbalanced
Level	max. +12dBu @ 100% modulation
FRONT PANEL	
Display	High-resolution OLED
Status Indicators	5 LEDs
Headphones	1/4" (6.3mm) phones jack
USER INTERFACE	
Indicators	OLED display + 5 LEDs on front panel
Web interface	Full control and status information
Connector	RJ-45
Type	Ethernet
Device discovery	UPnP support
OPERATING CONDITIONS	
Temperature	10°C - 45°C
Humidity	< 75%, non-condensing
POWER REQUIREMENTS	
Connector	IEC320
Power supply	100-240V / 50-60 Hz / 25W
SIZE AND WEIGHT	
Dimensions (W;H;D)	485 x 44 x 180 mm
Shipping Weight	540 x 115 x 300 mm / 2.6kg

Panel Indicators and Appointments

FRONT PANEL



1. Phones Output - The following audio signals are reproduced through the headphones:
 - Voice Announcement of DB9009-RX IP Audio Decoder's IP address upon startup;
 - Audio signal from the selected input.
2. LED Indicators
 - Power
 - Network
 - IP Audio
 - MP3 Audio
 - Memory
3. OLED Screen
4. Soft buttons

REAR PANEL

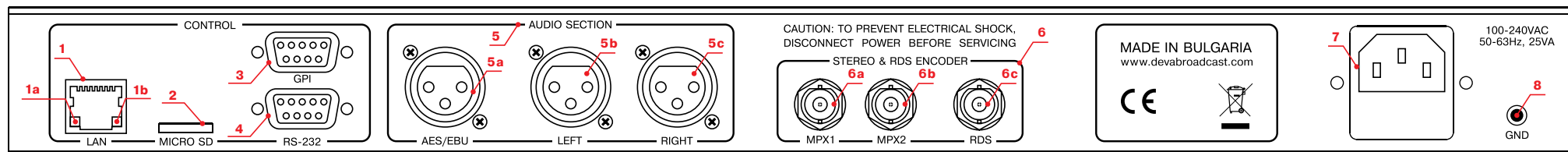

- 1- LAN Port / Internet Input – standard RJ-45 port:
- 1a - Network Activity LED Indicator (RJ-45 built-in);
- 1b - Network Availability LED Indicator (RJ-45 built-in);
- 2 - SD Card;
- 3 - GPI;
- 4 - RS-232 Serial COM Port - DB-9 Female Connector;
- 5 - Audio section:
- 5a - AES/EBU - Digital Audio Output – Balanced XLR Female;
- 5b - Left - Analog Audio Output – Balanced XLR Female;
- 5c - Right - Analog Audio Output – Balanced XLR Female;
- 6 - Stereo and RDS Encoder(will be available if Stereo & MPX Encoder Board is installed):
- 6a - MPX output 1;
- 6b - MPX output 2;
- 6c - RDS output;
- 7 - Power Supply;
- 8 - GND.

GPIO CONNECTORS PINOUTS

GPI Port Pinouts

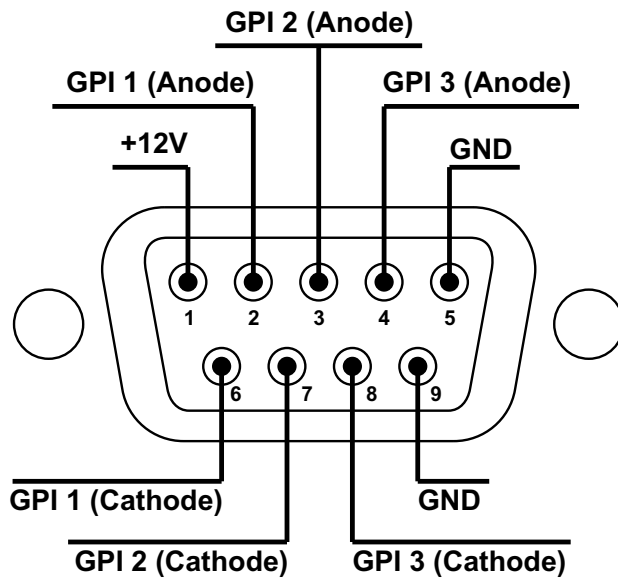

$I_F = 10 \text{ mA}$
 $I_{Fmax} = 50 \text{ mA}$

GPI 1 Example Connection

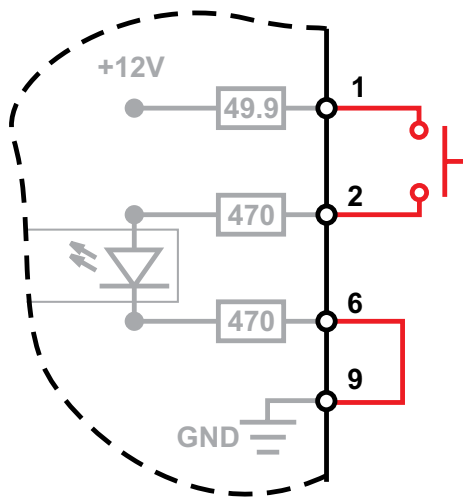

RS-232 Port Pinouts

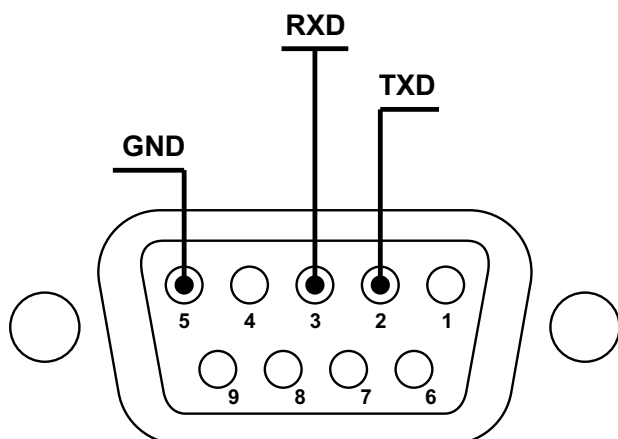

BLOCK DIAGRAM

A simplified block diagram of DB9009-RX IP Audio Encoder is shown below:

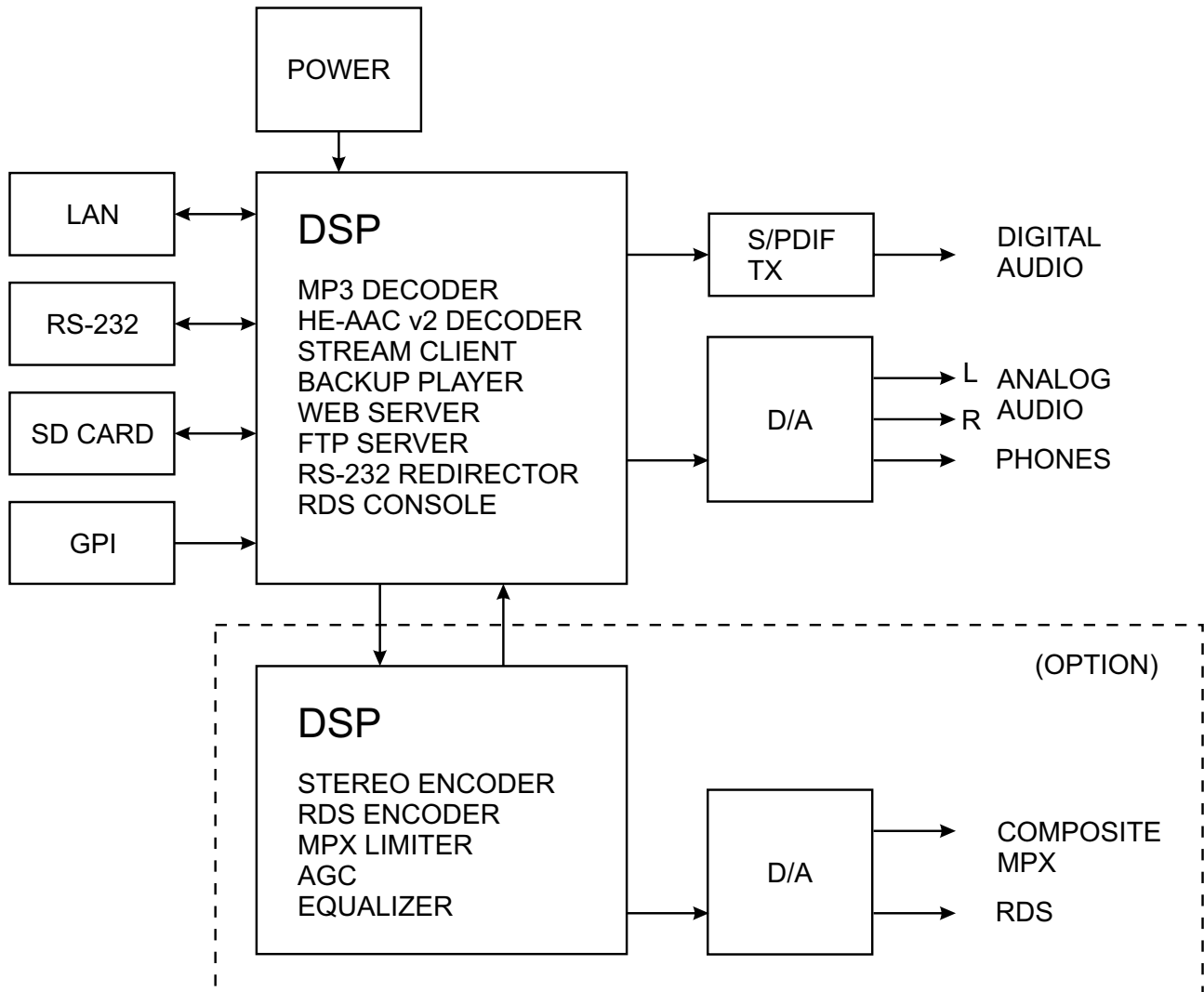

Because of the all-digital, minimalist-discrete-component nature of device circuitry, we have not provided schematic diagrams of the DB9009-RX in this Manual. Please, note that:

**NO USER-SERVICEABLE COMPONENTS INSIDE.
 REFER ALL SERVICING TO
 QUALIFIED TECHNICAL PERSONNEL.**

Safety Precautions

IMPORTANT: *Carefully read this paragraph as it contains important instructions concerning operator safety and directions regarding the installation, operation and maintenance of the equipment. Failure to observe the safety instructions and information given in this manual constitutes an infringement of the safety rules and design specifications provided for this piece of equipment. DEVA Broadcast Ltd. declines all responsibility if any one of the safety rules given herein is not observed. DEVA Broadcast Ltd. declines all responsibility if the end-user resells the product. The equipment is to be used by people capable of operating it in a trouble-free manner and it is assumed that they are aware of the following safety rules.*

- ◇ Keep this manual with the utmost care and close at hand so that it can be consulted whenever needed
- ◇ After unpacking the equipment, check its condition.
- ◇ Avoid banging the equipment.
- ◇ The packing material (plastic bags, polystyrene, nails, etc.) must never be left within reach of children, as these items are potential sources of danger.
- ◇ Do not use the equipment in places where the temperature is not within the recommended range, as specified by the manufacturer.
- ◇ Before connecting the equipment, make sure the nameplate specifications correspond to the mains electricity supply (the nameplate is located on the equipment enclosure).
- ◇ Do not remove the sticker from the equipment as it contains important specifications and the relevant serial number.
- ◇ To join the equipment to the mains supply, use the power cord purchased with the equipment.
- ◇ The equipment must be used only for the purposes it was designed for.
- ◇ Abuse or misuse of the equipment is extremely dangerous for people, pets and property. The manufacturer declines all responsibility for damage and injury resulting from improper use and mishandling.
- ◇ Certain basic safety rules must be observed when using electrical equipment, in particular:
 - Never touch the equipment with wet and/or damp hands or other parts of the body.
 - Keep the equipment away from drops of water or sprinkling systems.
 - Never use the equipment near high heat sources or explosive material.
 - Do not introduce any extraneous matter into the equipment.
 - Do not allow children or untrained people to use the equipment.
- ◇ Before cleaning or servicing the equipment outside, disconnect its power supply and wait at least 2 seconds before working on it, as recommended by current safety regulations.
- ◇ In the event of faults and/or improper operation, turn off the equipment, shut off the electrical power and call your dealer.
- ◇ Do not attempt to make repairs and/or adjustments when covers/guards or circuit boards are to be removed.
- ◇ Call your dealer for any repairs and be certain original spare parts are used. Failure to observe this rule may adversely affect the safety level of your equipment.
- ◇ The equipment is to be connected to the mains supply and provided with adequate and efficient earth conductors.
- ◇ When installing, leave a clearance of at least 1 cm around the equipment to allow air to pass freely.

Before you start

SAFETY WARNING

- The servicing of electronic equipment should be performed only by qualified personnel;
- Before removing the covers DB9009-RX must be switched off and the mains cable unplugged;
- When the equipment is open, the power supply capacitors should be discharged using a suitable resistor;
- Never touch the wires or the electrical circuits;
- Use insulated tools only;
- Never touch the metal connectors. They might carry high voltages;
- For removing and installing electronic components, follow the recommendations for handling MOS components.

ATTENTION: DB9009-RX has an internal Lithium battery. Do not try to re-charge this battery! Please contact us for detailed instructions in case the battery should be changed.

OPERATING RECOMMENDATIONS

For normal operation of DB9009-RX, we recommend following the instructions listed below.

- Install the unit in places with good air conditioning. DB9009-RX is designed to operate within the ambient temperature range of 10 to 50°C. The equipment rack should be ventilated in order for the device to keep its internal temperature below the maximum ambient temperatures;
- We do not recommend installation in rooms with high humidity, dusty places or other aggressive conditions;
- Locate the device away from abnormally high RF fields;
- Use only checked power supply cables. We strongly recommend the usage of shielded cables;
- Connect DB9009-RX only to reliable power supply sources. In case of unstable power supply, please use Uninterruptible Power Supply (UPS);
- Use the device only with its top cover on to avoid electromagnetic anomalies. Otherwise, this may cause problems with the normal functionality of the unit;
- For the normal remote operation of the unit, connect DB9009-RX to a good quality Internet connection;
- For the normal operation of DB9009-RX, check if the network settings pass through all the required data traffic.

Unpacking and Inspection

Upon receipt, the equipment should be inspected for possible shipping damages. If such are found or suspected, notify the carrier at once and contact DEVA Broadcast Ltd. The original shipping carton box and packing materials should be kept for possible reuse, in case of return for Warranty repair, for example. Shipping damages as a result of improper packing for return may invalidate the Warranty!

IT IS VERY IMPORTANT that the [“Product Registration Card” on page 58](#) included in the Manual be completed accurately and returned. This will assure coverage of the terms of the Warranty and it will provide a means of trace in case of lost or stolen equipment. In addition, the user will automatically receive SERVICE OR MODIFICATION INSTRUCTIONS from DEVA Broadcast Ltd.

Mounting

RACK EQUIPMENT

The DB9000-TX mounts in a standard 19-inch equipment rack and requires only 1¾ inches (1U) of vertical rack space. The use of plastic washers is recommended to protect the painted finish around the mounting holes.

HEAT DISSIPATION

Having very low electricity consumption, the DB9009-RX itself generates negligible heat. The unit is intended for operation within an ambient temperature range, extending from freezing to 120°F/50°C. But because adjacent, less efficient equipment may radiate substantial heat, be sure that the equipment rack is adequately ventilated to keep its internal temperature below the specified maximum ambient.

RADIO FREQUENCY INTERFERENCE

Although we have made provision for DB9009-RX installation in the immediate proximity of broadcast transmitters, please do practice some care using the unit near abnormally high RF fields.

Basic Setup

ANALOG AUDIO OUTPUTS

Using a cable ending with two standard XLR connectors connect DB9009-RX analog signal outputs to the analog audio inputs of your equipment.

DIGITAL AUDIO OUTPUT

Using a cable ending with a standard XLR connectors connect DB9009-RX AES/EBU output to the digital audio input of your equipment.

LAN PORT

For normal operation it is necessary DB9009-RX to be connected to a local network or Internet by cable with RJ-45 connector.

RS-232 COM PORT

Using standart DB-9 cable connect DB9009-RX to any RS-232 compatible equipment.

GPI PORT

The current audio source can be selected/forced using this GPI port.

Front Panel - OLED Display, Navigational & Soft Buttons

DISPLAY

The DB9009-RX's OLED display has three function areas: Header, Soft Buttons and Main Screen Working area.



HEADER AREA

Header is located on the left quarter of the screen. Depending on contents of working area the header may contains the following items:



1. Indicator to show the Left signal audio level
2. Indicator to show the Right signal audio level
3. Input - current audio source
4. Status – connection status
5. Signal properties – information on audio signal sample rate, bit rate and codec
6. Source name – audio stream title

SOFT BUTTONS

Soft buttons are located on the bottom side of the OLED Display making possible direct transition from some of the pages to another page. In such cases the inscription of a specified Soft Button corresponds to the page it is linked with. Most of the pages have the same or similar functionality distinctive segments (areas). Pressing of a specified Soft button causes a visual effect of pressing the appropriate Soft button on the OLED Display. Function, Menu Page, Parameter to be changed, etc., that are linked to a specified Soft button will appear as inscription on the button.

For example:

- Levels page
- Graphs page
- Menu page
- Status page

NOTE: On some pages the Header and Soft button area may be hidden.

MAIN SCREEN WORKING AREA

The Main part of the OLED Screen is the place where the information changes dynamically. The Menu Screen (shown below) appears after a short pressing of the [OK] Navigational Button. The DB9009-RX's Menu Page contains selectable icons and buttons for selecting modes and functionalities of this device. Pressing [Left] and [Right] arrow buttons changes icon selection of the Menu Page. An icon is selected when it receives the rectangle focus frame around it. Short pressing of the [OK] button on selected icon will make a transition to corresponding page. On figure below the Graphs icon is selected.



The following Operating Modes and Pages can be selected using the Navigational Buttons:

- Home Page
- Graphs page
- Levels page
- Settings page
- Status page
- About page

Operating Modes and Pages

HOME PAGE



Immediately after power-up and boot process of DB9009-RX, the Home page is shown on the display.

Transition to Home page can be made from any page where Soft Button is available. On the default home screen the Header area is shown ([see "Header Area" on page 21](#)), and the most important parameters also.

From the home page, using the [UP] and [DOWN] buttons, the following information can be found:

Main audio source

- Information on the main source. For example if IP Audio Client 1/2 is used - type, station, title, codec, SR and BR will be shown on the screen.

Backup 1

- Information on the first backup source. For example if RTP is used - sender, codec, SR and BR will be shown on the screen.

Backup 2

- Information on the first backup source.

GRAPHS PAGE

Select Graphs icon from Menu page and short press [OK] button on it, or press the soft button labeled Graphs. The transition to Graphs page will be made.

Graph page represents the value deviation of measured parameters in time. The X axis of the data plot area is elapsed time in seconds. New peak value sample is added to data graph on every 125ms. Up to 20 seconds of measurement history is available for each parameter. The most recent moment in time is on the right side of the graph. The name and the unit for Y axis of currently measured parameter is displayed on top left corner of data plot. On the right side of the display a bargraph indicator is used to display momentary value of selected parameter. The low and high limits of the measured range are also available in shaded color.

Button assignments:

[OK] – Transition to Main menu page.

[LEFT]/[RIGHT] – not used in this mode.

[UP]/[DOWN] – Changes currently displayed parameter history. The following parameters are available for observation:

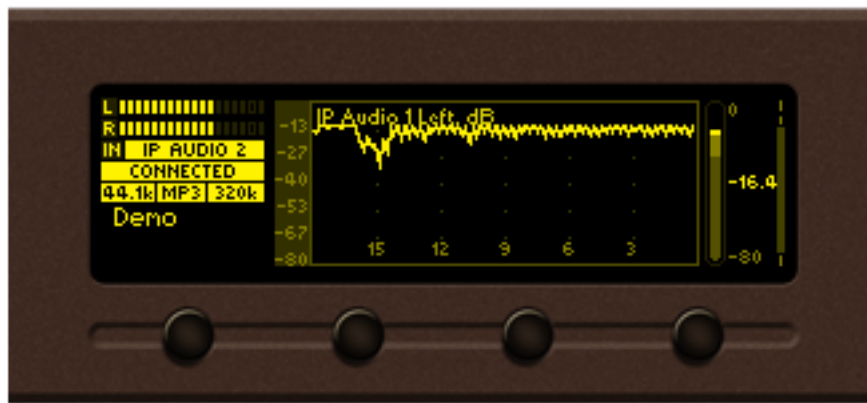

IP Audio 1 Left, measured in dB

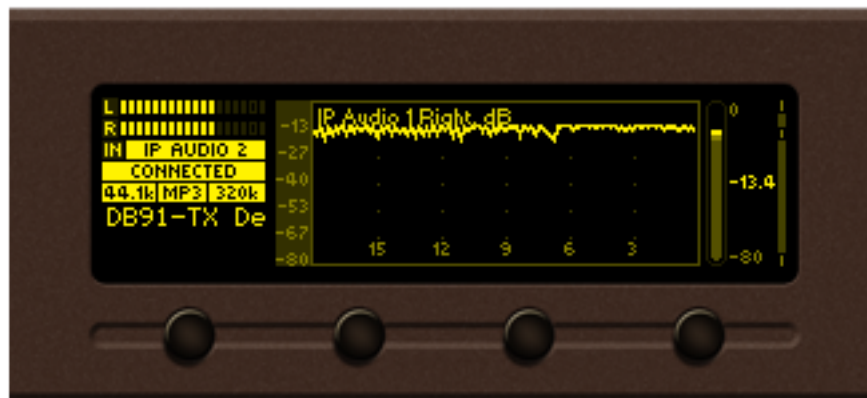

IP Audio 1 Right, measured in dB

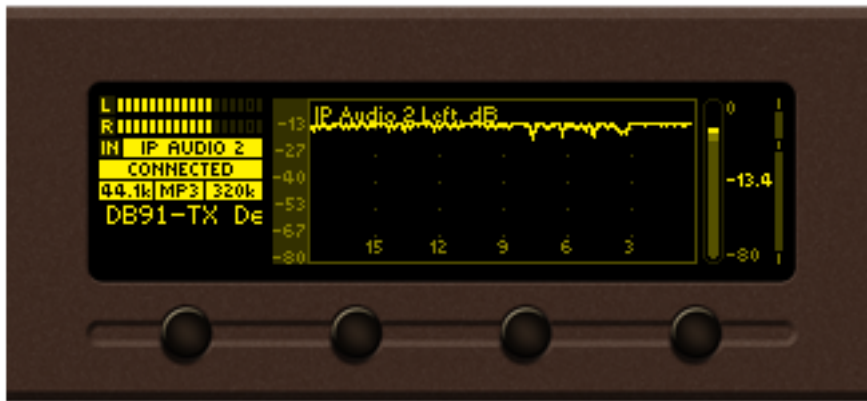

IP Audio 2 Left, measured in dB

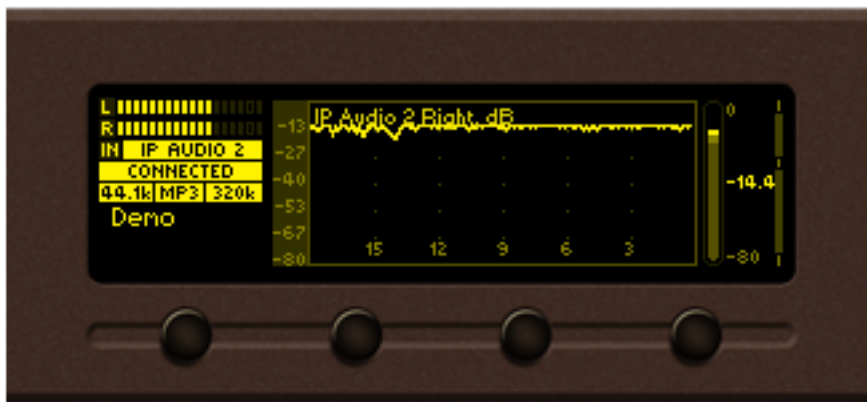

IP Audio 2 Right, measured in dB



IP Audio 3 Left, measured in dB



IP Audio 3 Right, measured in dB

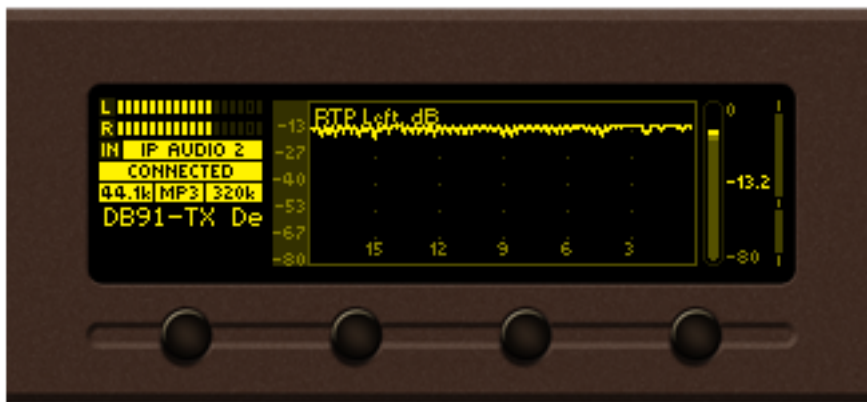

RTP Left, measured in dB

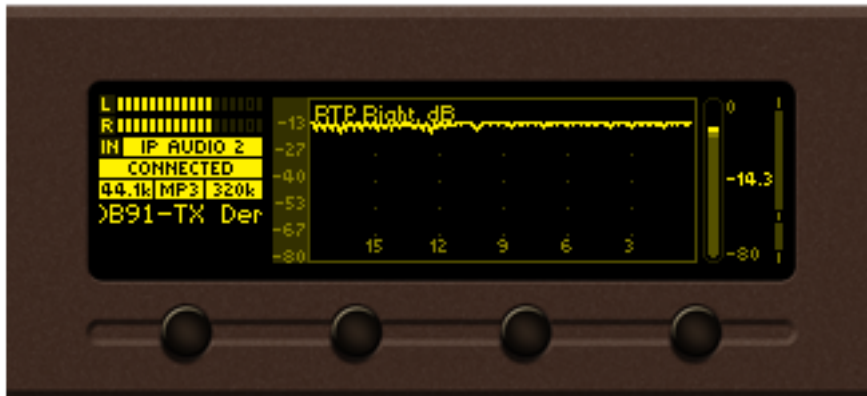

RTP Right, measured in dB

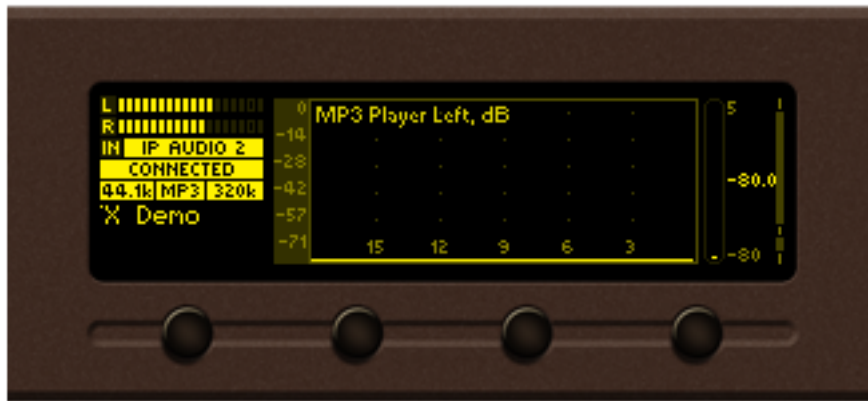

MP3 Player Left, measured in dB

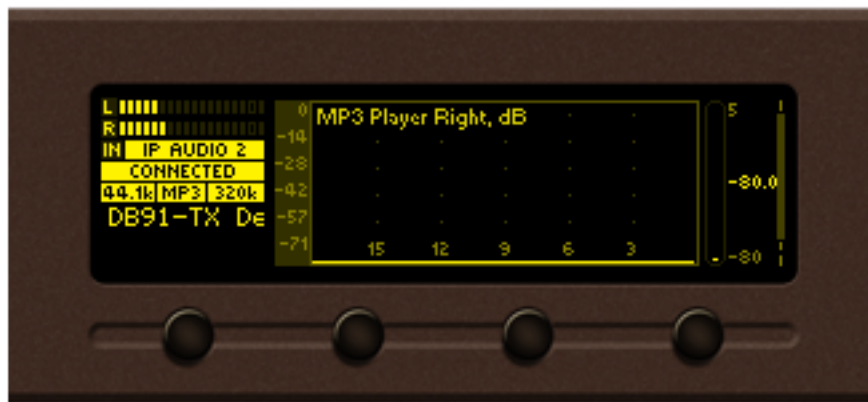

MP3 Player Right, measured in dB

LEVELS PAGE

Select Level icon from Menu page and short press [OK] button on it. The transition to Levels page will be made.



Levels page shows bargraph representation of different parameters, measured by DB9009-RX. The parameters are shown in group of four. Each bargraph displays averaged momentary value in highlighted color number, minimum and maximum peak values. Shaded color number found on the left and right bottom edges denotes the measurement range of the parameter. The name and measurement unit of the parameter is shown above corresponding bargraph.

SETTINGS PAGE

Select Settings icon from Menu page and short press [OK] button on it. The transition to Settings page will be made.

The device settings are organized as hierarchical tree menu (Settings menu). Similar parameters are grouped in sections (branches). The overall view of the Settings menu is shown on the figure below.



“Audio” section (branch) from the root Settings menu is selected



“Main Source” parameter from “Audio” branch is selected

There is several areas in the Settings menu screen:

Settings menu title

– shows the path to currently selected menu item. Note that parameter name should be considered in the context of settings menu title. For example Settings>Network>Email.

Navigation area

– the selection of certain branches / parameters is made here. The selected item is drawn in highlighted color. The names of the branches or parameters are listed on the right side of the navigation area. The value of the parameter is shown on the right – against the parameter name. Since branches have no values associated with them the tree dots are shown instead. This indicates a sublevel branch or parameter.

Button assignments:

[OK] – Acts differently depending on current selection. If selection is:

- Menu branch – the transition to selected branch is made and the branch items are listed in navigation area;
- Menu parameter – the value of that parameter is highlighted and edit mode is entered;

- Menu complex parameter (such as Alarm) – the parameter editor is shown and edit mode is activated;
[UP]/[DOWN] – If edit mode is active – changes the value of the selected parameter. Otherwise will move selection in corresponding direction up/down.
[LEFT]/[RIGHT] – Changes selection within parameter value in edit mode. See examples below.
[SB4] – Back one level or cancel menu mode.

There is several parameter types available in DB9009-RX. The way of editing depends of that type. Following is description of parameter types. Every parameter has several properties, change step, unit, default value, permitted range for its value and so on.

Numerical parameter (INT). Represents numerical value.

Example:



Button assignments for INT in edit mode:

[OK] – Accept the value and exits edit mode.

[UP]/[DOWN] – Changes the value of the parameter with one step increment/decrement. The value always stays in permitted parameter range.

[SB4] – Discards the value and cancels edit mode.

Enumerated parameter (ENUM).

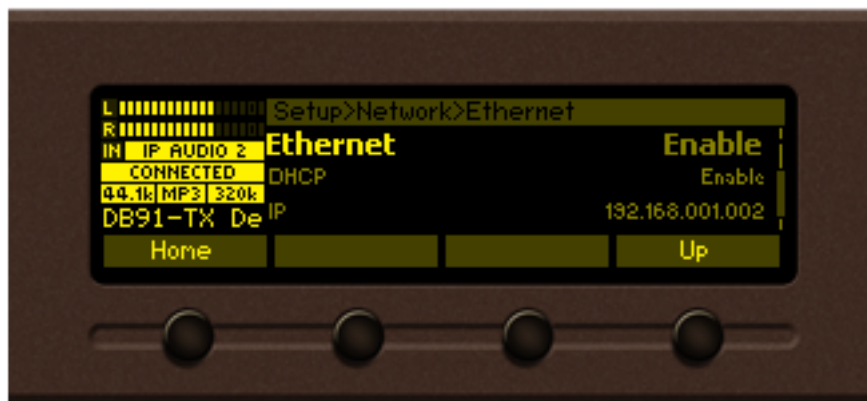

Represent selection of one value from set of predefined enumerated values. Example: The value can be changed between “Enable” and “Disable” position. Button assignments for ENUM in edit mode:

[OK] – Accept the value and exits edit mode.

[UP]/[Down] – Cycles through possible value positions. The value always stays in permitted parameter range.

[SB4] – Discards the value and cancels edit mode.

IP address (IP). Represents IPv4 address.

Example:

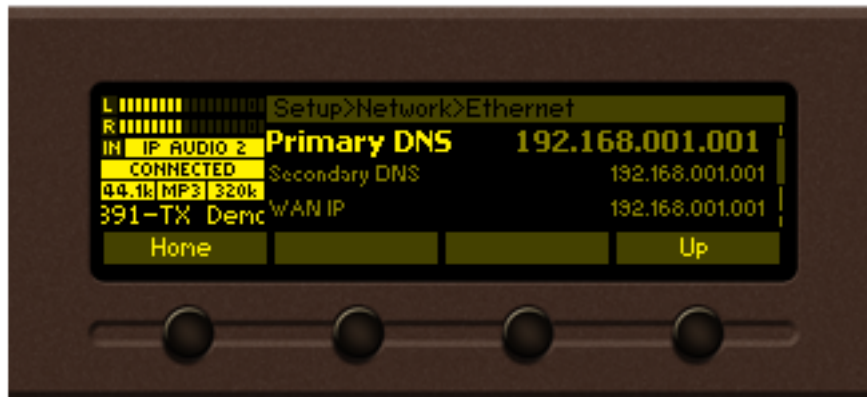

Button assignments for IP in edit mode:

[OK] – Accept the value and exits edit mode.

[UP]/[DOWN] – Cycles through possible values for selected (highlighted background) segment of IP address. The value always stays in permitted parameter range.

[LEFT]/[RIGHT] – Selects previous/next segment from the IP address.

[SB4] – Discards altered value and cancels edit mode.

IP port (PORT). Represents IP port.



Button assignments for IP port in edit mode: See IP address description.

String (STR). Represents string.



Button assignments for STR in edit mode:

[OK] – Accept the value and exits edit mode. Note that certain String, like e-mail addresses, are validated prior acceptance. If validation fails the message box is displayed and edit mode is not left after message box confirmation. For example:

[UP]/[DOWN]– Cycles through possible values for selected (highlighted background) string character. There is certain limitation in permitted charset depending from string context.

[LEFT]/[RIGHT]– Selects previous/next character from the string. If [RIGHT] button is pressed with the last character selected the new space character is added automatically at the end of the string **User Name** **user**. On [LEFT] button press the trailing spaces are removed automatically.

[SB2] – Inserts white space before selected character.

User Name **user** - before [SB2] press

User Name **user** - after [SB2] press

[SB3] – Deletes selected character.

User Name **user** - before [SB3] press

User Name **us** - after [SB3] press

[SB4] – Discards altered value and cancels edit mode.

Date (DATE). Represent date information.



Button assignments for DATE in edit mode:

[OK] – Accept the value and exits edit mode.

[UP]/[DOWN]– Cycles through possible values for selected (highlighted background) segment of parameter value. The value always stays in permitted parameter range.

[LEFT]/[RIGHT]– Selects previous/next segment from the parameter value.

[SB4] – Discards altered value and cancels edit mode.

Time (TIME). Represent time information.

Button assignments for TIME in edit mode: See DATE description.

Timer (TIMER). Represents relative time interval.

Button assignments for TIMER in edit mode:

[OK] – Accept the value and exits edit mode.

[UP]/[DOWN]– Increments/decrements value with one step. The unit of the value changes automatically from seconds to minutes and vice-versa.

[SB4] – Discards altered value and cancels edit mode.

STATUS PAGE

Information on the device's status, IP address, etc. can be found here.

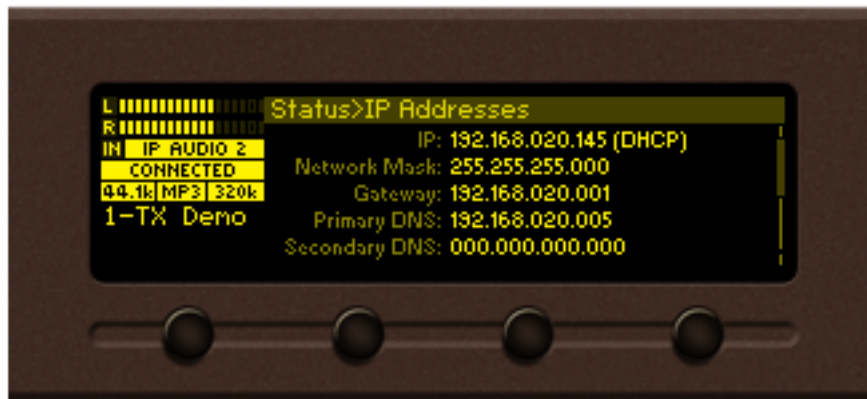

ABOUT PAGE

Information on the device's model and contacts of the manufacturer can be found here.



WEB Interface

DB9009-RX is controlled through a built-in WEB Server and a standard web browser can be used to monitor its status or to make some adjustments. To operate the device you need to know its IP Address. In case you are not aware of it, you can hear it through the headphones when you turn on the device. Alternatively, use the Network discovery feature at Local networks

Open a new WEB Browser and enter the device IP address in the address field then press [Enter]. Due to the inability of some WEB browsers to read the IP address format displayed on the screen of the device, the numbers included in the IP address must be written without the leading zeros. For example: 192.168.020.095 must be written as 192.168.20.95

A window that requires username and password will appear. Default values being Username: *user* or *admin*, Password: *pass*

NETWORK DISCOVERY

This is a network setting that defines whether your computer can see (find) other computers and devices on the network and whether other computers on the network can see your computer. By default, Windows Firewall blocks network discovery but you can enable it.

1. Open Advanced sharing settings by clicking the Start button, and then on “Control Panel”. In the search box, type “network”, click “Network and Sharing Center”, and then, in the left pane click “Change advanced sharing settings”;
2. Select your current network profile;
3. Click Turn on network discovery, and then click save changes.

NOTE: If you're prompted for an administrator password or confirmation, type the password, provide confirmation or contact your system administrator.

If you have already enabled this function on your computer DB9009-RX will be automatically added to the Device list section. The device will be ready for usage and no additional adjustments will be required except user name and password.

ACCESS

DB9009-RX provides you with a protected access to the device settings. You can choose between two types of log in:

1. As an ADMINISTRATOR – it will give you full control over the settings (username: *admin*, password: *pass*);
2. As a USER – this type of log-in will allow you only to monitor the device (username: *user*, password: *pass*).

In order to make the necessary adjustments to the device, please log in as an ADMINISTRATOR.

WEB Interface Menu pages

STATUS

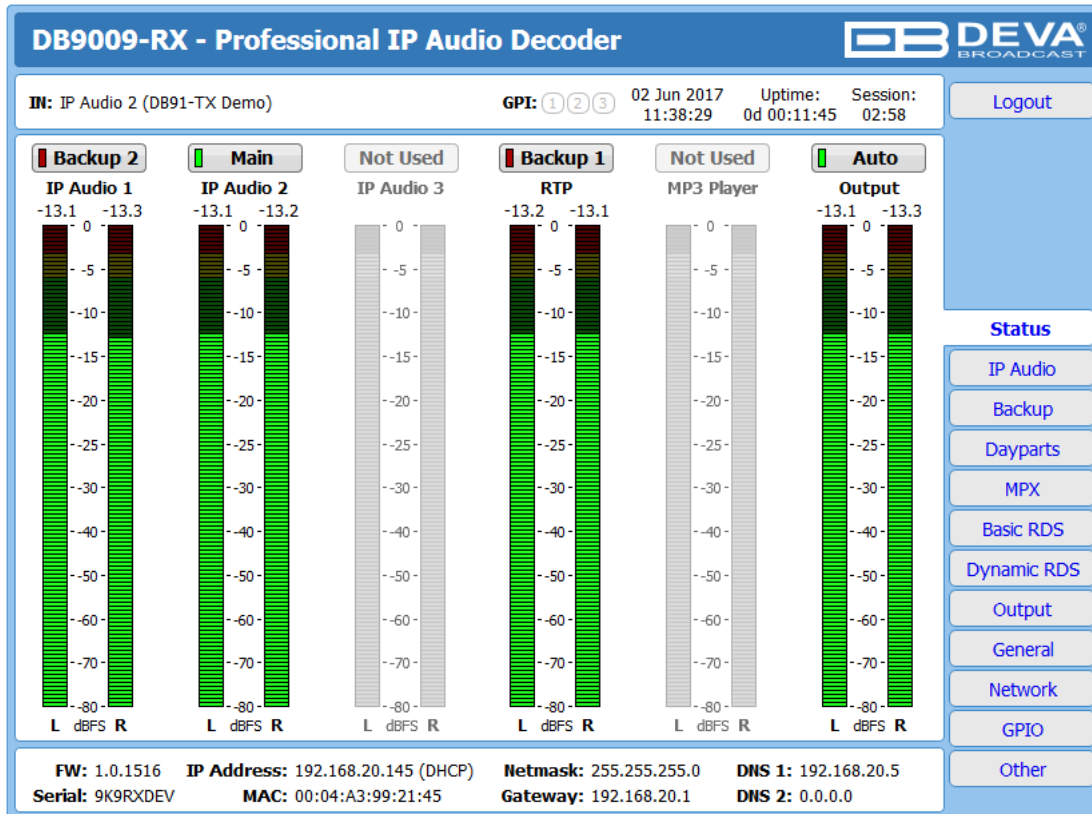

Upon opening the WEB interface, the main Status window will appear. The page contains information on the device's current status - the LED bar-graph representation of the left and right audio levels in dBFS, for the IP Audio Clients (1, 2, 3), RTP, MP3 player and Output.

At the top of the control window is placed a constant section, containing information about the input in use, GPI, Date/Time, Uptime and session timeout.

At the bottom of the control window is an information bar, gathering all the important connection parameters – firmware version in use, serial number, IP Address, and etc.

Upon change of the Web Interface screens, the main status window will resize automatically and become a constant part of each tab. Thus, allowing reading at a glance of all the mandatory parameters.

SETTINGS

DB9009-RX - Professional IP Audio Decoder

IN: IP Audio 2 (DB91-TX Demo) GPI: ① ② ③ 13 Jun 2017 12:13:09 Uptime: 0d 00:00:27 Session: --:--

Backup 2 **Main** **Not Used** **Not Used** **Backup 1** **Auto**

IP Audio 1 **IP Audio 2** **IP Audio 3** **RTP** **MP3 Player** **Output**

-80.0 -80.0 -5.5 -5.8 -0 - -0 - -80.0 -80.0 -5.4 -5.7

0 - 0 - 0 - 0 - 0 - 0 -

-10 - -10 - -10 - -10 - -10 - -10 -

-20 - -20 - -20 - -20 - -20 - -20 -

-30 - -30 - -30 - -30 - -30 - -30 -

-50 - -50 - -50 - -50 - -50 - -50 -

-70 - -70 - -70 - -70 - -70 - -70 -

Welcome!

Username:

Password:

[Status](#)

[Settings](#)

DB9009-RX provides you with a protected access to the device settings. In order to make the necessary adjustments to the device, please log in as an ADMINISTRATOR (username: *admin*, password: *pass*).

IP AUDIO

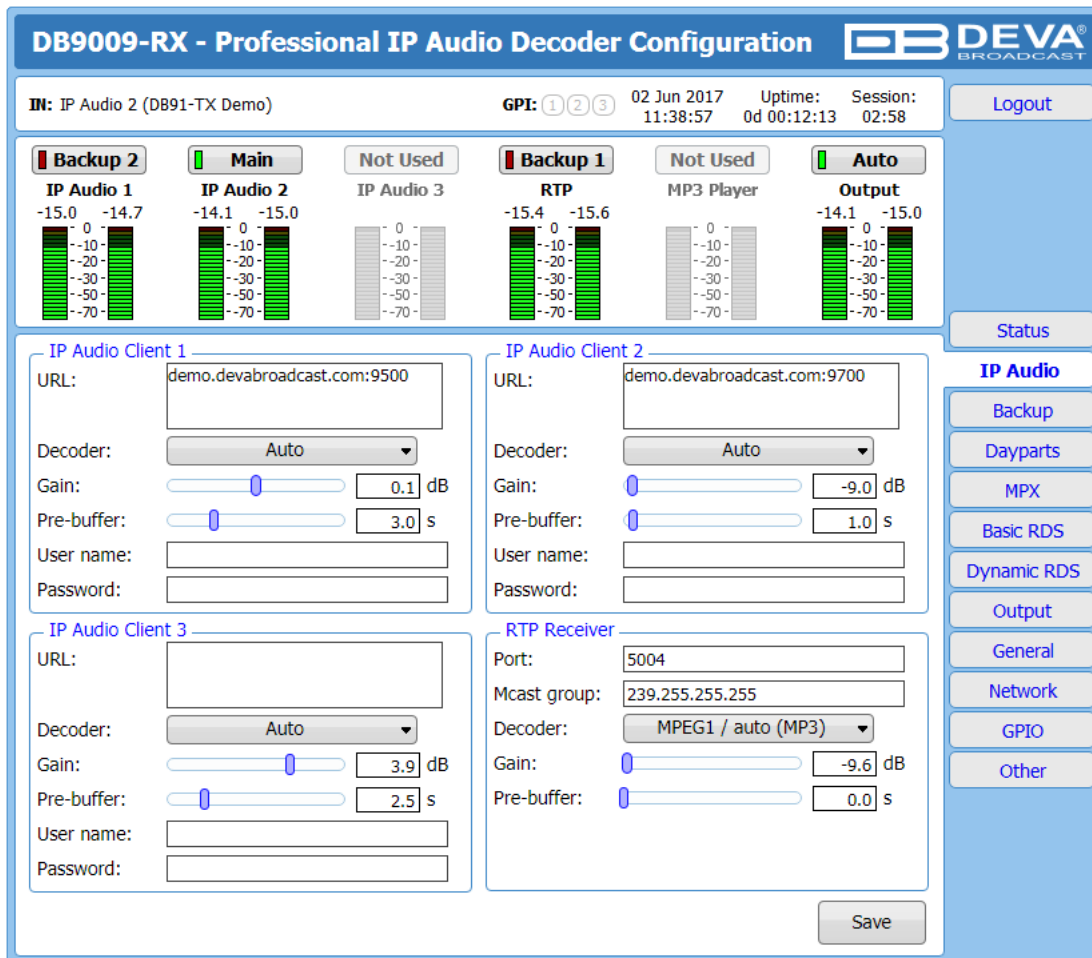

The settings applied to IP Audio Client 1, 2 and 3 are identical– Set Decoder from the dropdown menu, and URL of the stream server. Up to 63 characters can be entered.

Decoder (+ Sample rate) – Select decoder and sample rate. It can be set to Auto or manually set to a known decoder and sample rate. In Auto mode, the DB9009-RX will adjust decoder and sample rate, using stream supplied information. For PCM (uncompressed) sample rate can be 32 kHz, 44.1 kHz or 48 kHz. For MPEG1 and HE-AAC the sample rate is determined automatically from the stream;

Gain – audio source gain adjustment. The Gain adjust is digital and if the sum of signal level and the Gain is greater than 0dBFs the signal will be distorted;

Pre-buffer – The minimum amount of time in which the unit will pre-buffer before playing starts in order for problems with the connection to be prevented.

NOTE: In order to ensure normal operation when PCM is used, it is necessary to select the same sample rate at both encoding and decoding side.

User name & Password – enter **User name** and **Password** if the stream server is password protected. Otherwise leave blank.

RTP Receiver – Specify **Port**, **Decoder**, **Gain**, **Pre-Buffer** adjustments and **Multicast group IP**.

FOR YOUR INFORMATION: A multicast address (Mcast group) is a logical identifier for a group of hosts in a computer network, that are available to process datagrams or frames intended to be multicasted for a designated network service.

NOTE: In order the applied settings to be used press the [Save] button, placed on the bottom right part of the screen.

BACKUP

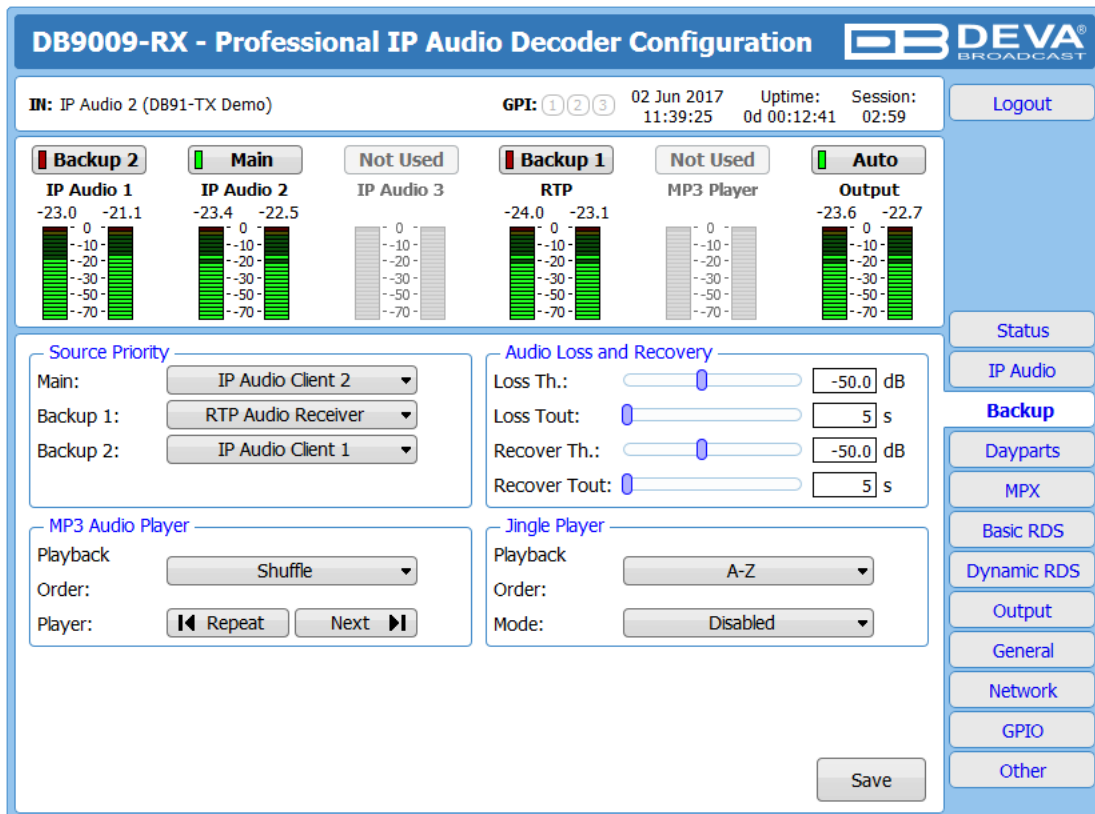

All needed settings to the alternative sources are applied through this screen. The backup sources priority is user-defined and can be set through the relevant section. If the audio from the main source disappears, the DB9009-RX will automatically switch to the first backup source; if it also fails, the unit will switch to the second. Once a source with higher priority is restored, the unit will switch back to it.

Audio Loss and Audio Recover – Select the appropriate levels of loss and recovery of the audio signal. Do not forget to set the corresponding timeouts.

MP3 Audio Player – The Playback Order can be changed from here. The following options are available: A-Z, Z-A, Shuffle, Playlist, and Shuffled Playlist. Information on the used and available SD card storage respectively, could also be found in this section. [Repeat] and [Next] button to navigate through the playlist if need be, are also available.

MP3 Files Upload via FTP – Through the use of a standard FTP client, you have the opportunity to update the backup content at will via any PC. The supported format is .mp3. An important requirement for the MP3 Player configuration is that all MP3 files should be stored in a folder named Audio (no sub-folders are allowed). The folder should be located in the root of the SD Card. The playlist file must be named playlist.m3u.

Jingle Player – This option is available only when the audio source is set to MP3 Audio Player. The Jingle player is designed for playing jingles (speech and music) at different intervals specified by the user. The intervals are counted by songs. From the Mode drop down menu the number of songs after which a jingle should be played is chosen. The Playback Order is also user-defined. Generally speaking, the Jingle Player allows you to make a simple radio play out.

Jingle Files Upload via FTP – Through the use of a standard FTP client, you have the opportunity to update the backup content at will via any PC. The supported format is .mp3. An important requirement is that all jingles should be stored in a folder named ‘Jingles’ (no subfolders are allowed). The folder should be located in the root of the SD Card. The playlist file must be named playlist.m3u. For information on how the connection between the DB9009-RX and an FTP Client should be configured, please [refer to “Download files via FTP” on page 60](#).

How can a playlist file be made?

1. All backup audio files, and the play list must be located in a single folder named Audio.
2. Use a plain text editor to create a file named playlist.m3u.
3. The file should be stored in the same directory where the MP3 files are (folder Audio);
4. The play list should contain only the names of the files, without path.
For example: Track1.mp3
5. Each track name should be on a new line.
6. The song titles should be written in the order that should be played.

DAYPARTS

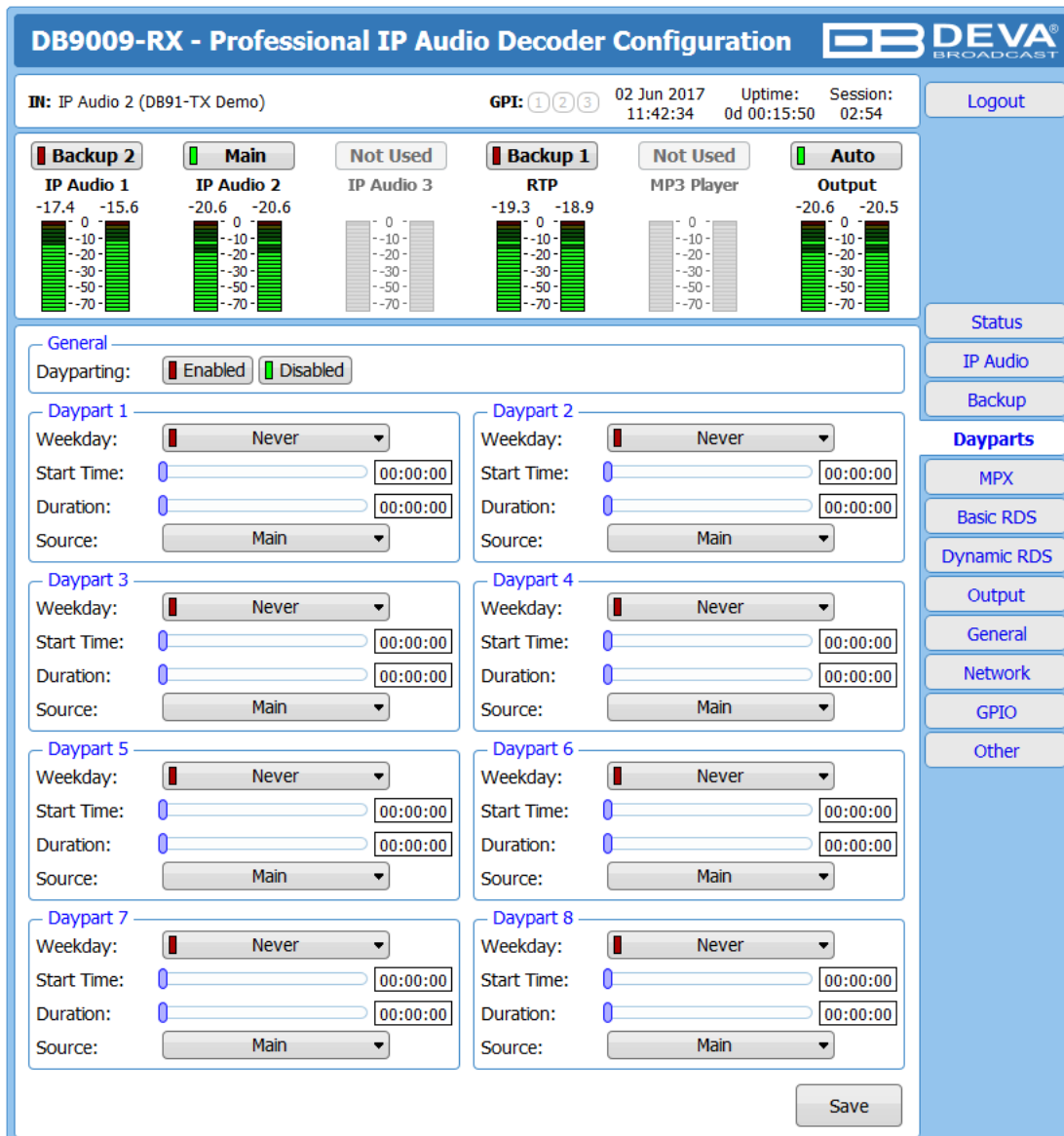

Dayparting is the practice of dividing the day into several parts, during which a different type of audio source will be used. This function will allow a broadcasting pattern based on the radio's timetable to be made. Generally enable the Dayparts function in order to use it. Please bear in mind that if the option is generally disabled the function will not be used, nevertheless the applied settings in sections *Daypart 1* to *Daypart 8*.

There are eight positions at your disposal that can be set. The settings to be applied for each of them are identical:

1. Set the desired **Weekday** from the drop-down menu. For your convenience, the option *Every day* is also available;
2. Set the **Start Time** and **Duration**;
3. To finalize the setup, select the **Source** that should be used during this time period. Repeat the same procedure for each of the positions that should be used.

NOTE: If the **Weekday** is set to *Never* the relative daypart will not be used. It is recommended the unused dayparts to be set to *Never*.

MPX

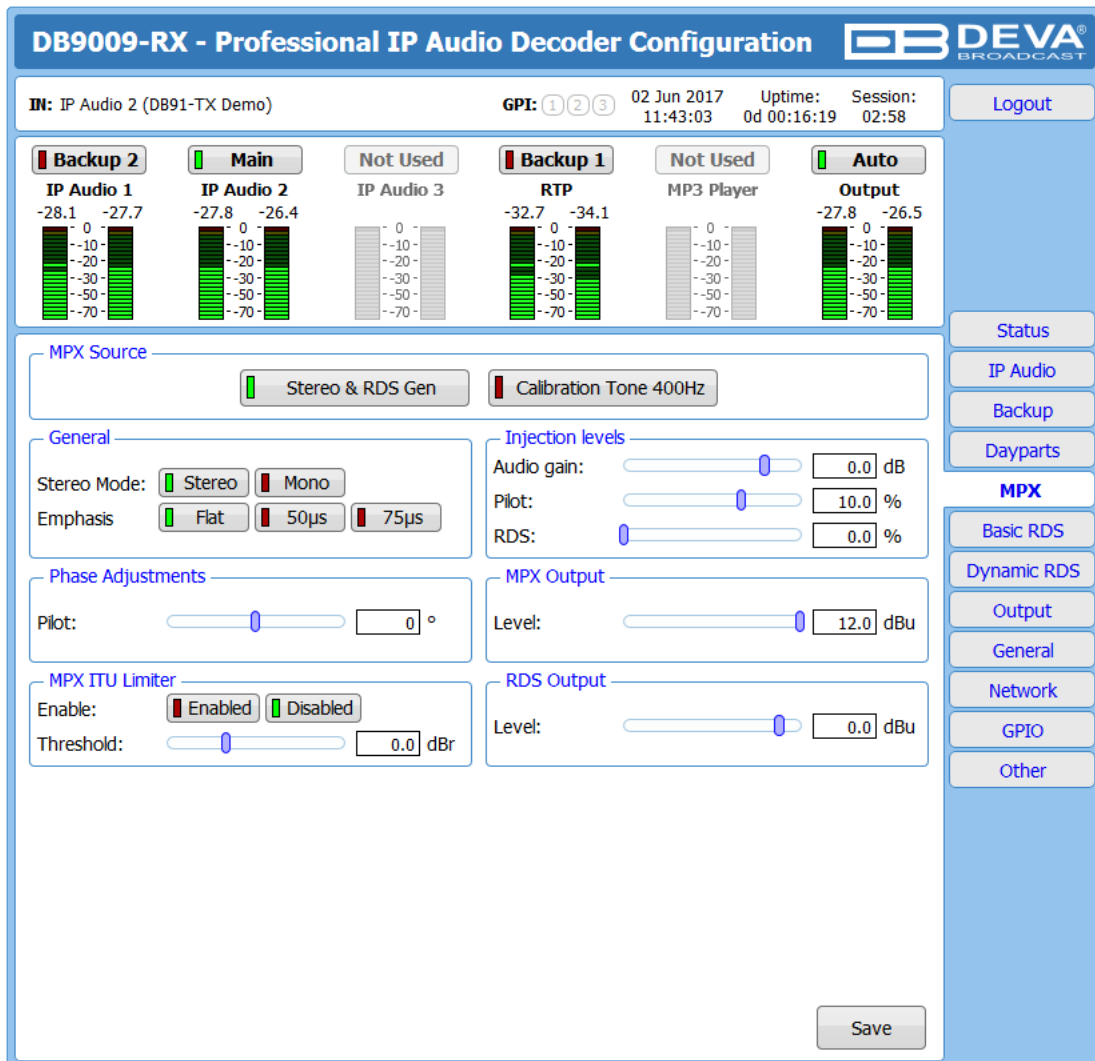

The screenshot displays the configuration page for the DB9009-RX Professional IP Audio Decoder. At the top, it shows the title 'DB9009-RX - Professional IP Audio Decoder Configuration' and the DEVA BROADCAST logo. Below the title, there is a status bar with 'IN: IP Audio 2 (DB91-TX Demo)', 'GPI: 1 2 3', the date '02 Jun 2017', 'Uptime: 11:43:03', and 'Session: 0d 00:16:19 02:58'. A 'Logout' button is located in the top right corner.

The main configuration area is divided into several sections:

- Audio Levels:** A row of six level meters. 'Backup 2' (IP Audio 1) shows levels of -28.1 and -27.7. 'Main' (IP Audio 2) shows levels of -27.8 and -26.4. 'Not Used' (IP Audio 3) is greyed out. 'Backup 1' (RTP) shows levels of -32.7 and -34.1. 'Not Used' (MP3 Player) is greyed out. 'Auto' (Output) shows levels of -27.8 and -26.5.
- MPX Source:** Two buttons: 'Stereo & RDS Gen' (selected) and 'Calibration Tone 400Hz'.
- General:** 'Stereo Mode' with 'Stereo' selected and 'Mono' unselected. 'Emphasis' with 'Flat' selected and '50µs' and '75µs' unselected.
- Injection Levels:** Sliders for 'Audio gain' (0.0 dB), 'Pilot' (10.0 %), and 'RDS' (0.0 %).
- Phase Adjustments:** A slider for 'Pilot' set to 0°.
- MPX ITU Limiter:** 'Enable' with 'Enabled' selected and 'Disabled' unselected. 'Threshold' slider set to 0.0 dB.
- MPX Output:** A slider for 'Level' set to 12.0 dBu.
- RDS Output:** A slider for 'Level' set to 0.0 dBu.

A 'Save' button is located at the bottom right of the configuration area. On the right side of the interface, there is a vertical menu with buttons for 'Status', 'IP Audio', 'Backup', 'Dayparts', 'MPX', 'Basic RDS', 'Dynamic RDS', 'Output', 'General', 'Network', 'GPIO', and 'Other'.

MPX Source – Set the preferred MPX Source.

Stereo & RDS Gen – MPX generated from the built-in Stereo and RDS Generator.

Calibration Tone 400Hz - single tone of 400Hz, used for calibrating of the inputs of the devices connected to the MPX output.

General – The settings of the Stereo Generator are applied through this section.

Stereo Mode – Switch between Stereo and Mono Mode for MPX signal. Note that Mono Mode disables the 38 kHz sub-carrier.

Emphasis – The pre-emphasis operation consists of amplifying the high audio frequency levels as compared to the low audio frequencies. The purpose of this is to reduce the signal/noise ratio in a proportion of 10 to 15dB by performing the inverse operation at the receiving level. There is 50µS for Europe and 75µS for USA options available.

Injection Levels – Set the levels of the components included in the obtained final Stereo Multiplex Signal.

Audio Gain – Allows audio gain at the input of the Stereo coder to be selected. By default, the Audio Gain is set to 0 dB.

Pilot – Adjusts the modulation level of the pilot tone as a component of the MPX signal.

RDS – Adjusts the modulation level of the RDS subcarrier as a component of the MPX signal.

Phase Adjustment – The phase of the Pilot Tone, L-R sub-carrier (38 kHz) and RDS sub-carrier (57 kHz) are factory adjusted. Additional adjustments can be made by the user providing more flexibility in DB9009-RX settings.

- MPX Output** – Select output level of the MPX signal.
- MPX ITU Limiter** – Enable or Disable the MPX Limiter.
- Threshold** – the input level above which the signal is reduced.
- RDS Output** – Select output level of the RSD signal.

IMPORTANT NOTE: The MPX tab will be available/active only if Stereo & RDS Encoder module is installed. If not, the following message will appear:

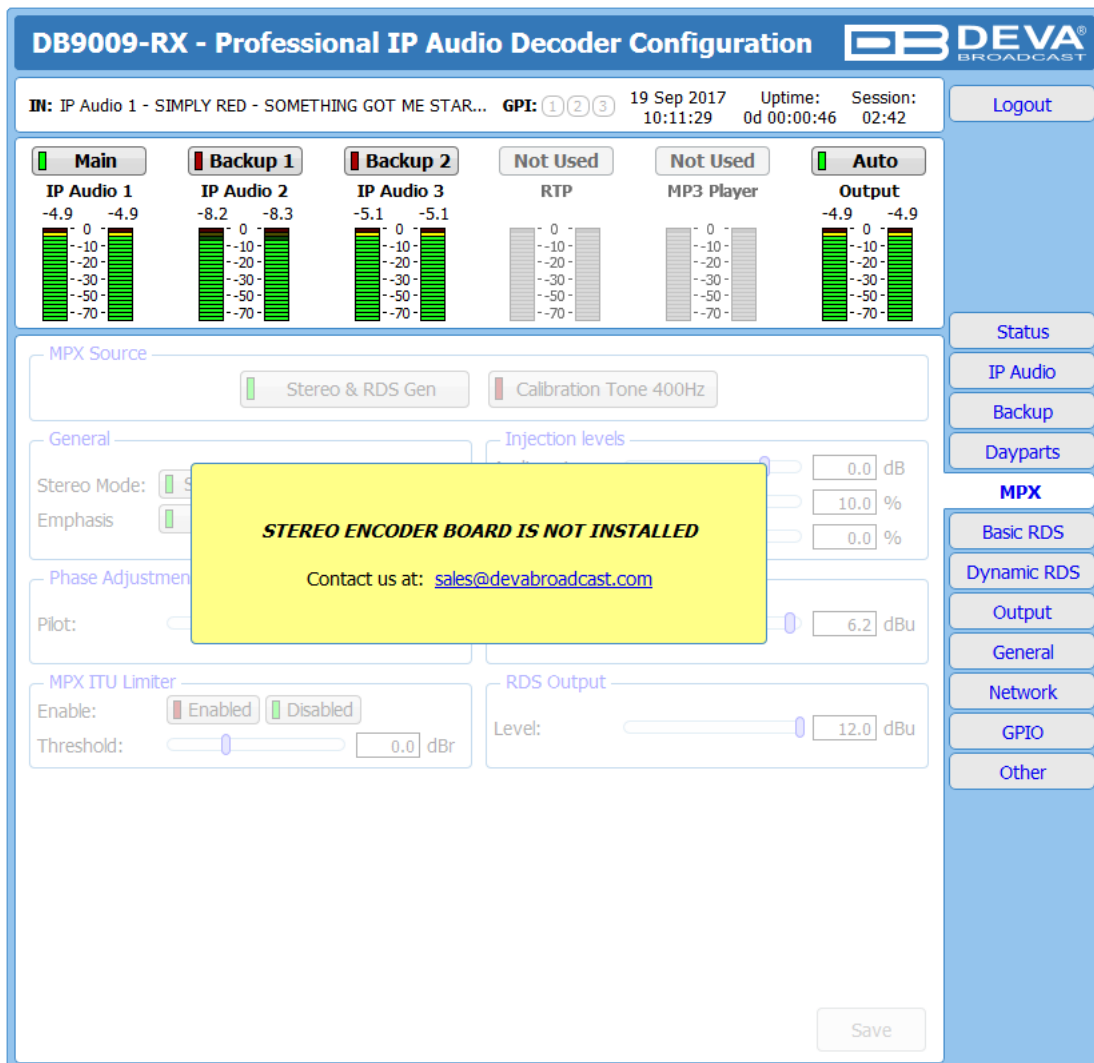

The Stereo & RDS encoder board is an option that could be added. If you would like to purchase one, please contact us at sales@devabroadcast.com.

BASIC RDS

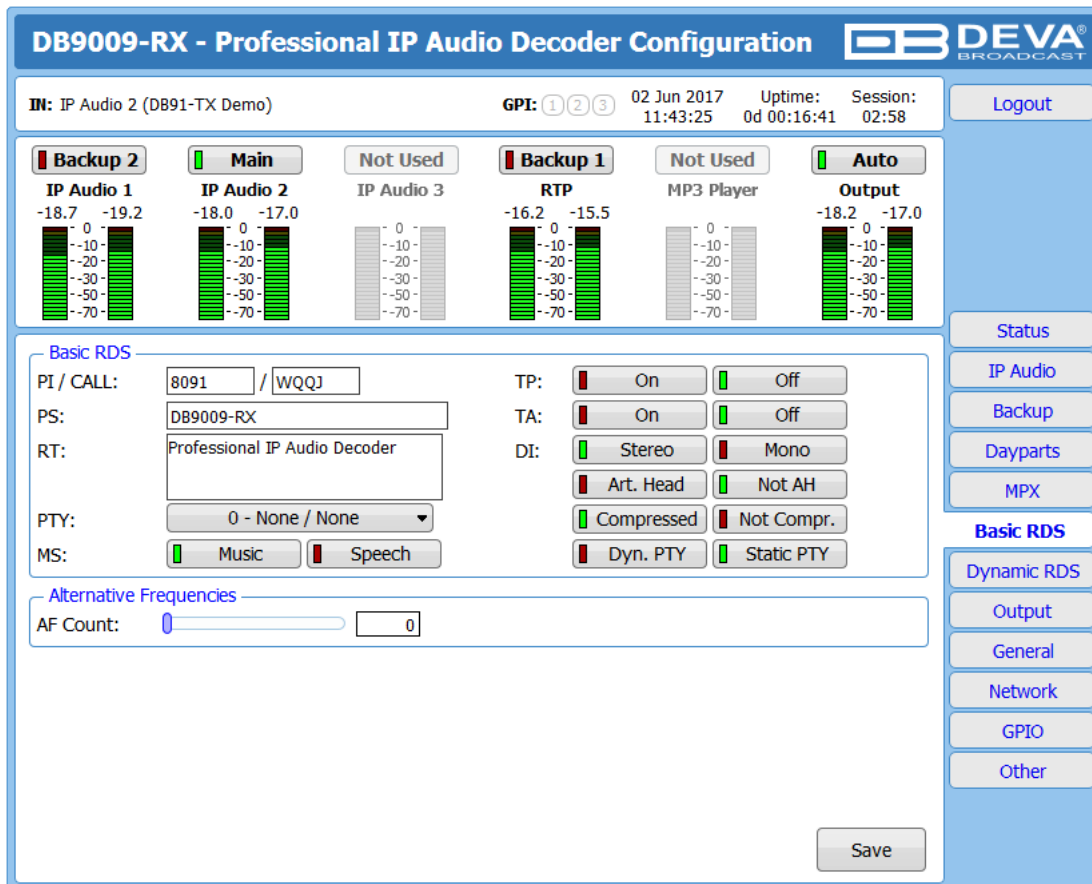

All basic elements of the RDS/RBDS are displayed on the screen – **PI**, **PS**, **RT**, **TA/TP** and etc. The **Alternative frequencies** are also available, represented as a list. The number of the **AF** can be set via the **AF Count** Slider. Once the needed quantity of **AFs** is set, the frequencies for each of them should be specified.

PI/CALL (Program Identification) – The **PI** code is your station’s ‘digital address’. It is a hexadecimal code that is assigned by an appropriate broadcasting authority in most countries, but in the United States the **PI** code is numerically calculated from the station’s call sign. We have provided a calculator utility. An in-depth discussion of the mathematical calculation is given in RDS/RBDS Standard. To use the **PI** calculator for US ‘K’ and ‘W’ call signs, simply enter call letters into the **CALL** box. The hexadecimal code will automatically be calculated into **PI** box. If the hexadecimal code for a US station is known, you may enter it under **PI**, and then the call sign will be calculated automatically into **CALL** box. When **PI** calculator fails to calculate **PI** or **CALL** the corresponding box will be filled with ‘----’.

PS (Program Service Name) – This is the station’s “street name” that will appear on the receiver faceplate display. The **PS** can be up to eight characters in length (including spaces) and can be as simple as the station’s call letters: KWOW or KWOW FM, or a slogan: NEWSTALK or LIVE 95.

RT (Radio Text) – This is a 64-character block of plain text that the listener can select for visual display on the faceplate of the radio by pressing an **INFO** button on the receiver. This function is not available on many automobile radios for safety reasons, which has precipitated the frowned-upon practice of scrolling the **PS** field instead. The **Radio Text** can announce song titles and performers, run special promotions or contests, or broadcast sponsors’ messages.

PTY (Program Type) – The **PTY** data flag identifies the station format from a pre-defined categories. Many RDS receivers are able to seek the listener’s preferred format automatically. This means that a car radio can switch from a fading station to a stronger one that carries the same variety of music, though not the very same program, as provided by AF switching. The **PTY** function of RDS helps a broadcaster catch ‘transient audience’ share. The **PTY** code is not meant to change from song to song or to accommodate a top-of-the-hour newscast, however.

MS (Music/Speech Switch) – This flag simply indicates whether music or speech is the primary broadcast programming.

TP (Traffic Program Identification) – The **TP** flag identifies the station as one that routinely broadcasts traffic bulletins for motorists as part of its normal, everyday programming. When the **TP** flag is displayed on the receiver faceplate, the radio is searching for traffic announcements. The radio keeps track of **TP** stations offering this service to speed up the search-and-switch process.

TA (Traffic Announcement) – This is a temporary flag added to the RDS data stream only when a traffic bulletin is being aired. Some RDS car radios can be set to search for traffic bulletins among various **TP** stations while tuned to a listener’s preferred program, or even while playing a tape or CD. As soon as any **TP** station broadcasts a traffic bulletin, the receiver temporarily switches-over to receive it. When the bulletin is finished, the receiver switches back to the original program, tape or CD.

DI (Decoder Information) – This is one of several ‘flags’ that convey yes/no or other very basic data. This particular flag tells the receiver whether the broadcast is monaural, or is being transmitted in any of several methods of stereo or binaural broadcasting.

List of Alternative Frequencies – A network broadcaster, or one with low-power rebroadcast transmitters (translators) to fill holes in his coverage area, can include a list of all frequencies where the identical program can be heard simultaneously. The RDS receiver (particularly the upscale car radio) constantly searches for the best signal that carries the very same program. When a better signal is found, the radio re-tunes with no noticeable interruption. The principal utility of this RDS function is with European radio networks and US stations with ‘translators’.

IMPORTANT NOTE: The Basic RDS tab will be available/active only if Stereo & RDS Encoder module is installed. If not, the following message will appear:

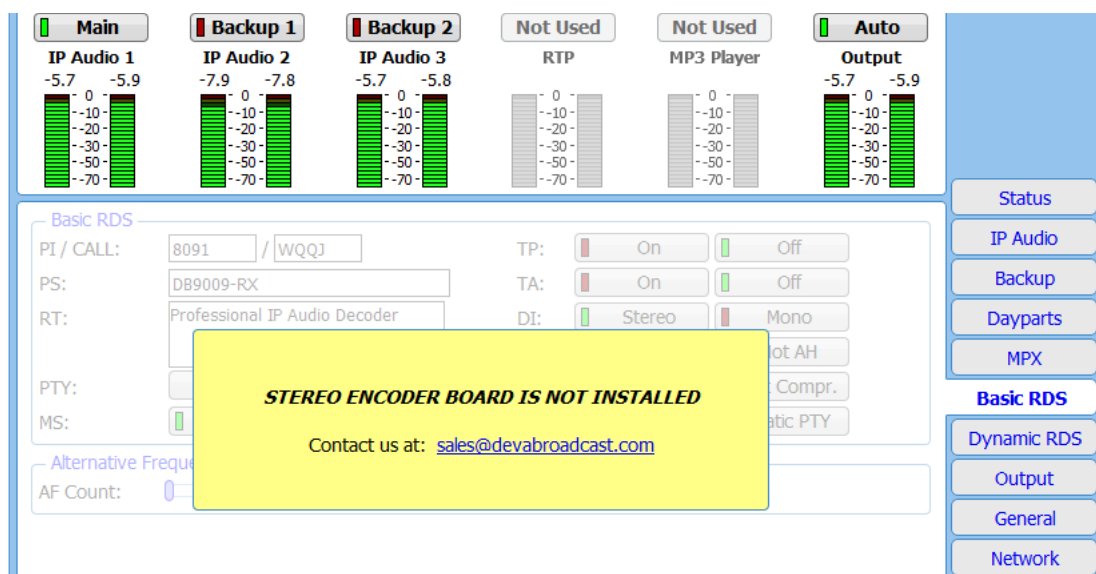

The Stereo & RDS encoder board is an option that could be added. If you would like to purchase one, please contact us at sales@devabroadcast.com.

DYNAMIC RDS

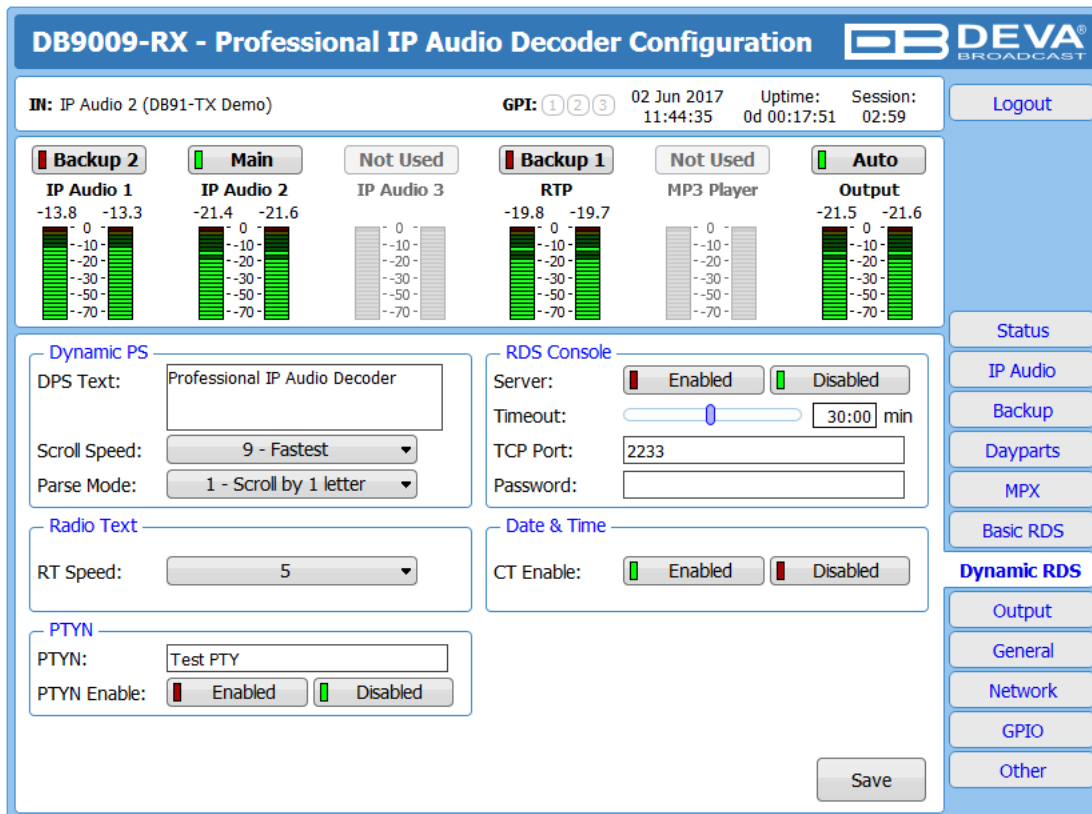

Dynamic PS ‘marches’ the message across the display screen one character at a time. The message requires a much longer transmission time in this mode, but a glance at the radio display a few seconds still allows the driver to get the full message without missing words.

Scroll Speed – The speed of dynamic PS messaging is set here, or dynamic PS messaging can be turned off entirely. When 0 - **DPS Disabled** is selected, the dynamic PS message remains in the nonvolatile encoder memory, but only the 8-character default static “street name” typed into the PS field (Basic RDS) will be displayed on the receiver faceplate. Setting the speed at 1 - **Slowest** will result in the slowest refresh rate of the ‘block’ message, or slowest safe scrolling. 9 - **Fastest** is the fastest speed, but many RDS radios display gibberish at high speed settings. The display should be stable with any radio at a speed setting of 7 or lower.

Parse Mode – sets the scroll step to be used in the “block” mode message transmission, more popular as ‘grouped-word’ method. Once Parse Mode option is set, this encoder function is valid for any scrolling-PS message, whether it is entered into the static DPS register, or received as ASCII text from station automation. Very short words are sent together in groups. For example, THIS IS constitutes seven characters that can be sent as a group. The same is applicable for OF THE or **NOW HERE**, also. Longer words, up to and including 8 characters, are sent individually: WARNING or DOUGHNUT or BICYCLE. The device can either center words that are sent individually on the radio display or left-justify them. This will be covered along with the function of the ‘DPS Scroll Step’. Words that exceed the available 8 characters are ‘sidestepped’ through two or more consecutive displays. Examples: EMERGENC followed by MERGENCY, or SUPERMAR followed by UPERMARK and PERMARKE and ERMARKET. This method of splitting words gives a good sense of continuity and readability. Setting Parse Mode to 1 - **Scroll by 1 letter** will scroll the message one character at a time, as described. Other numbers also safe-scroll the message, but at 2, 3, 4, and up to 8 characters at a time. Selecting 9 - **Left Justified** will parse, as described, but text will be left-justified rather than centered on the display. 2 through 8 may be useful in some special RDS applications, but 0 and 1 are the primary Parse Mode selections. To recap: 0 - **Centered** will

enable the more-popular, centered-auto-parsed block mode and **1 - Scroll by 1 letter** the Dynamic PS, letter-by-letter option.

Radio Text

RT Speed – The Radio Text update rate is programmed by setting RT Speed =n , with n a number between 1 and 9, corresponding to a refresh rate between slow and fast, respectively. Keeping the throughput tradeoff in mind, unless Radio Text is being used for contests or for other quasi dynamic activities, it is best to use a lower number. A rate of 1, 2 or 3 will make little difference in the speed of other RDS functions.

Radio Text can be turned off entirely by setting: RT Speed =0. A zero value in this field turns the Radio Text message off, but does not delete any saved message from memory. The RT (Radio Text) is set in Basic RDS tab.

PTYN (Program Type Name Settings)

PTYN – Program Type Name is transmitted as 8-bit characters. PTYN must only be used to enhance Program Type information and it must not be used for sequential information.

PTYN Enable – [Enable] or [Disable] type 10A group transmission. This group allows further description of the current Program Type.

Date & Time Settings

CT Enable – [Enable] or [Disable] type 4A group transmission. Enabling this group allows date and time information to be transmitted.

Console Settings

Server – [Enable] or [Disable] the RDS console remote access.

Timeout - allows session timeout to be specified. Upon expiration of the time set the connection will be closed.

TCP Port – a field where TCP port of the RDS console is to be entered. This console is used to edit RDS settings in real time. Default value is 2233.

Password – Password for the RDS console. These are the first symbols that must be sent to authenticate to the RDS console, otherwise the connection will be cancelled. If left blank NO security is used. Default value is blank (empty).

HOW TO CONNECT TO THE RDS CONSOLE

The RDS console is used to edit the RDS settings in real time. It can be used with an automation software or a terminal program.

To use the console, follow the steps listed below:

1. Connect to the TCP port of the RDS console with a terminal program or an automation software;
2. A welcome message HELLO will be received if proper connection is established;
3. If password is needed, the following message will appear PASS?;
4. Proceed with entering the commands.

RDS Console syntax

```
HELLO  
pass↵  
PASSOK  
PI=1234↵  
OK  
PI?↵  
1234  
OK  
TP=3↵  
NO
```

Depicted above is a sample RDS console conversation when a password is not set. The red text represents the user input and the black text - the console's responses. The ↵ symbol represent the Enter key on the keyboard.

- First row – is the welcome message from the RDS console. Next the user types in the password (in this case 'pass'), followed by Enter.
- Third row is the response meaning that the password is accepted and the user may proceed with commands.
- Fourth row is a 'set' command. These types of commands are used to set new value to RDS parameters. In the example above 'PI' is the Program Identification command, '=' (equal sign) means set new value and '1234' is the new value. The Enter key represents command's end and signals the RDS console to execute the command.
- Fifth row is a positive response from the RDS console. It means the command is accepted and executed successfully.
- Sixth row is a 'get' command. These types of commands are used to return the current value of RDS parameters. In the example above 'PI' is the Program Identification command, '?' (question mark) means return PI's value. The RDS console responds with the current value (in this case '1234') and positive response on the next row.
- Ninth row is again a 'set' command. In this case: Set Traffic Program to 3. The response is negative because the parameter TP can only have value 0 or 1.

List of available RDS console commands and their responses

PARAMETER	COMMAND	DATA ENTRY
INIT	INIT	Applies the default settings.
Program Identification	PI	4 digit HEX number (station "digital address")
Program Service	PS	8 (max) ASCII characters (station "street name")
Dynamic PS	DPS	64 (max) ASCII characters (for messaging in PS field)
Dynamic PS Speed	DPSS	0 to 9 (0 = Off, 1 = slow, 9 = fastest)
Dynamic PS Method	PARSE	0 through 9 (0 = parsed, centered; 1-8 = Safe Scrolling; 9 = parsed, left)
PTYN	PTYN	Sets Program Type Name
Program Type	PTY	1 or 2 digit number (describes station format)
Traffic Program	TP	0 or 1 (0 = no, 1 = yes)
Traffic Alert	TA	0 or 1 (0 = flag off, 1 = flag on)
Alternative frequencies	AF	0 to 204 (0 = blank; 1 to 204 = "channel" in 100 kHz increments, 87.6 MHz to 107.9 MHz)
Decoder Information	DI	1 digit HEX number
Music/Speech	MS	0 or 1 (0 = speech-only, 1 = music)
Radio Text	TEXT	64 (max) ASCII characters
Radio Text Speed	DRTS	0 to 9 (0 = RadioText off; 1 to 9 = update rate, slow to fast)
Command Echo	ECHO	0 or 1 (0 = echo off, 1 = echo on)
CT group 4A control	CTON	0 (disables) or 1 (enables) type 4A Group Transmission
PTYN group 10A control	PTYNON	0 (disables) or 1 (enables) type 10A Group Transmission
AF count	AFCOUNT	Sets the numbers of AFs transmitted.

SPECIAL COMMAND	MEANING
=	Set parameter value. Following a parameter command sets new value to that parameter; e.g.: PI=1234
?	Get parameter value. Following a parameter command returns status of encoder memory for that parameter; e.g.: AF3?
??	Returns all data in encoder memory.
INIT	Initializes the encoder to all factory defaults.

RESPONSE	MEANING
HELLO	Welcome message when connection to the console is established. If security is enabled proceed with entering the password. Otherwise proceed with commands.
PASS?	Password request. Will appear if such os set.
PASSOK	Password accepted, may proceed with commands.
PASSFAIL	Wrong password. Connection is dropped immediately
OK	Command received by encoder properly formatted and understood.
NO	Command properly formatted but data not understood.
BYE	Console has been inactive for more than 30 minutes and the connection will be dropped. User needs to connect again to enter more commands.
(NO RESPONSE)	Data sent is ignored by DB9009-RX.

OUTPUT

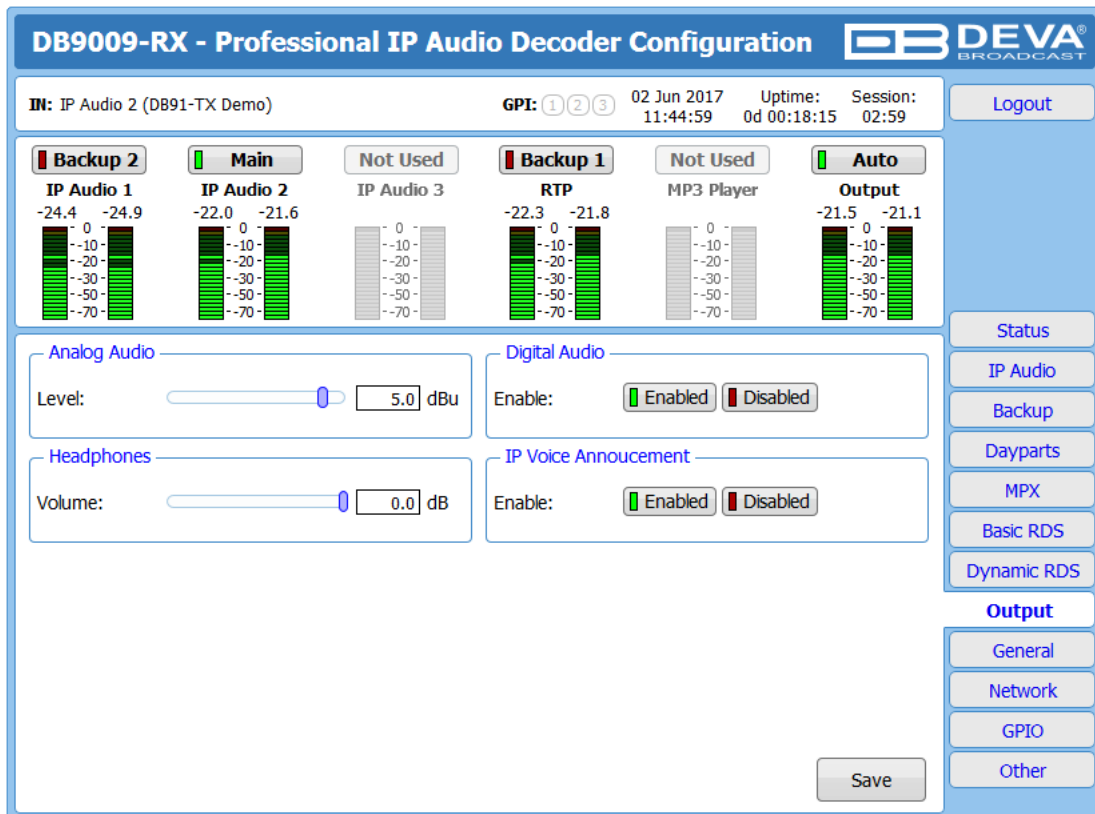

The screenshot displays the configuration page for the DB9009-RX Professional IP Audio Decoder. At the top, it shows the title 'DB9009-RX - Professional IP Audio Decoder Configuration' and the DEVA BROADCAST logo. Below the title, there is a header bar with the following information: 'IN: IP Audio 2 (DB91-TX Demo)', 'GPI: ① ② ③', '02 Jun 2017 11:44:59', 'Uptime: 0d 00:18:15', and 'Session: 02:59'. A 'Logout' button is located in the top right corner.

The main configuration area is divided into several sections:

- Backup 2**: IP Audio 1 (-24.4, -24.9 dB) and IP Audio 2 (-22.0, -21.6 dB). Both have level meters and are currently active.
- Not Used**: IP Audio 3 (-0, -0 dB).
- Backup 1**: RTP (-22.3, -21.8 dB) and MP3 Player (-0, -0 dB).
- Auto**: Output (-21.5, -21.1 dB).

Below the level meters, there are four control panels:

- Analog Audio**: Level slider set to 5.0 dBu.
- Digital Audio**: Enable checkbox checked (Enabled).
- Headphones**: Volume slider set to 0.0 dB.
- IP Voice Announcement**: Enable checkbox checked (Enabled).

On the right side of the interface, there is a vertical menu with buttons for: Status, IP Audio, Backup, Dayparts, MPX, Basic RDS, Dynamic RDS, **Output** (highlighted), General, Network, GPIO, and Other. A 'Save' button is located at the bottom right of the configuration area.

Analog Audio – set the level of the Analog Audio output (in dBu).

Digital Audio– enable or disable the Digital Audio output.

Headphones – set the level of the Headphones output.

IP Voice Announcement - Enables or disables the IP Voice Announcement option. By default and to ease the set-up process the option is enabled. Once the set-up process is completed, it is recommended the option to be disabled. Otherwise, the IP Voice Announcement will continue to be played.

NOTE: In order the applied settings to be used press the [Save] button, placed on the bottom right part of the screen.

GENERAL

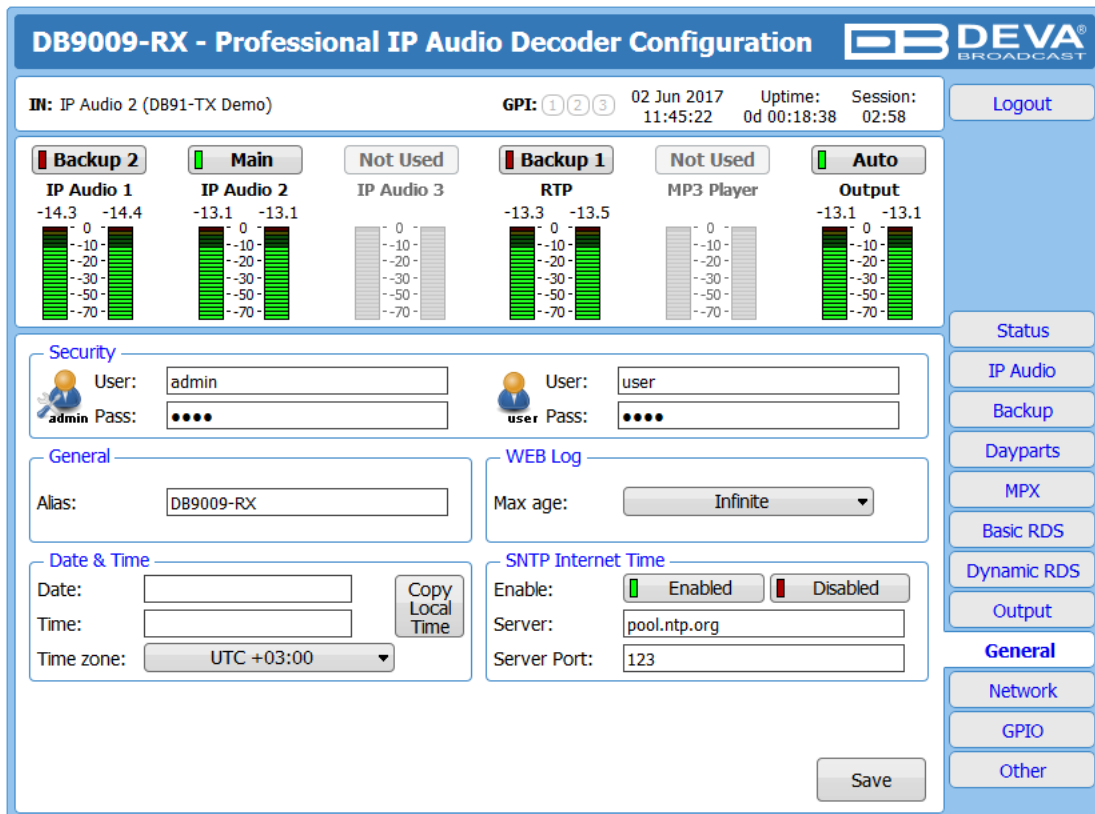

The screenshot displays the configuration page for the DB9009-RX device. At the top, it shows the device name 'DB9009-RX - Professional IP Audio Decoder Configuration' and the DEVA BROADCAST logo. Below this, there's a status bar with 'IN: IP Audio 2 (DB91-TX Demo)', 'GPI: 1 2 3', the date '02 Jun 2017', 'Uptime: 11:45:22', and 'Session: 0d 00:18:38 02:58'. A 'Logout' button is in the top right.

The main area is divided into several sections:

- Audio Levels:** Six meters for 'Backup 2', 'Main', 'Not Used', 'Backup 1', 'Not Used', and 'Auto'. Each meter shows levels for 'IP Audio 1', 'IP Audio 2', 'IP Audio 3', 'RTP', 'MP3 Player', and 'Output'.
- Security:** Fields for 'User' (admin, user) and 'Pass' (masked).
- General:** 'Alias' field set to 'DB9009-RX'.
- WEB Log:** 'Max age' dropdown set to 'Infinite'.
- Date & Time:** 'Date', 'Time', and 'Time zone' (UTC +03:00) fields, with a 'Copy Local Time' button.
- SNTP Internet Time:** 'Enable' checkbox (checked), 'Server' field (pool.ntp.org), and 'Server Port' field (123).

A 'Save' button is located at the bottom right of the configuration area. A sidebar on the right contains buttons for 'Status', 'IP Audio', 'Backup', 'Dayparts', 'MPX', 'Basic RDS', 'Dynamic RDS', 'Output', 'General', 'Network', 'GPIO', and 'Other'.

DB9009-RX provides you with protected access to the device settings. You can choose between two types of log in.

- As an ADMINISTRATOR – It will give you full control over the device's settings;
- As a USER – that will allow you to just monitor the device, while all the settings remain locked.

In order for the security of DB9009-RX to be enhanced, new username and password could be set from the Security section.

By choice, you can change the name of the device (General section). Later on, it will be used as a title name on all WEB pages. Customizing the name will make the device more recognizable.

Date & Time – used for manually determining the current Date and Time. [Copy Local Time] button will set the Date & Time to correspond to that of your computer.

SNTP Internet Time – Synchronizes automatically DB9009-RX's clock time with the Internet time server. Enable this function in order to use it (Specifying the server closest to your location will improve the accuracy).

WEB Log – the maximum storage time of the log files is chosen from here. Log files older than the specified will be permanently deleted.

NOTE: In order the applied settings to be used press the [Save] button, placed on the bottom right part of the screen.

NETWORK

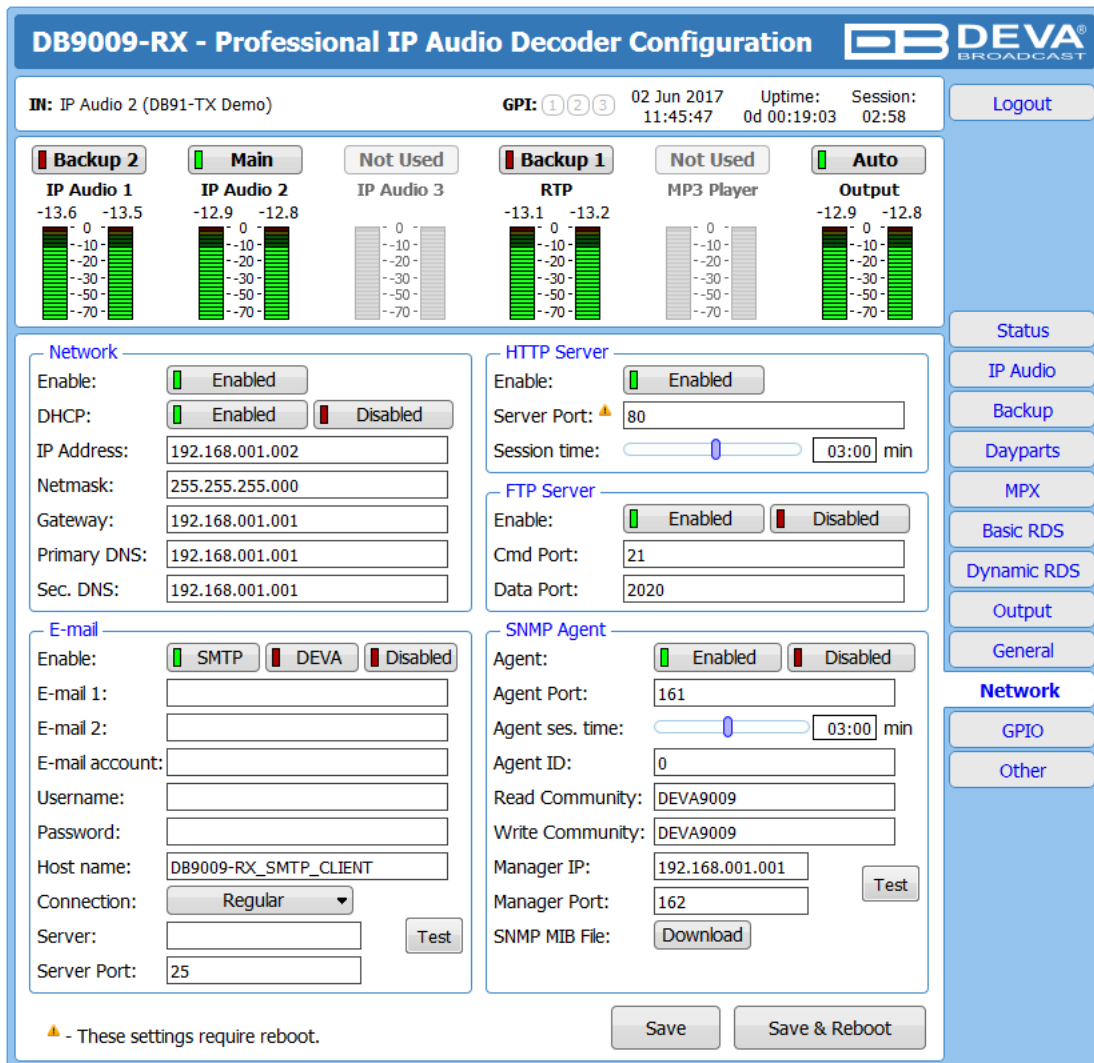

DB9009-RX - Professional IP Audio Decoder Configuration

III: IP Audio 2 (DB91-TX Demo) GPI: ① ② ③ 02 Jun 2017 Uptime: Session: Logout
 11:45:47 0d 00:19:03 02:58

Backup 2 **Main** **Not Used** **Backup 1** **Not Used** **Auto**

IP Audio 1 **IP Audio 2** **IP Audio 3** **RTP** **MP3 Player** **Output**

Network

Enable: Enabled

DHCP: Enabled Disabled

IP Address: 192.168.001.002

Netmask: 255.255.255.000

Gateway: 192.168.001.001

Primary DNS: 192.168.001.001

Sec. DNS: 192.168.001.001

HTTP Server

Enable: Enabled

Server Port: 80

Session time: 03:00 min

FTP Server

Enable: Enabled Disabled

Cmd Port: 21

Data Port: 2020

E-mail

Enable: SMTP DEVA Disabled

E-mail 1:

E-mail 2:

E-mail account:

Username:

Password:

Host name: DB9009-RX_SMTP_CLIENT

Connection: Regular

Server: Test

Server Port: 25

SNMP Agent

Agent: Enabled Disabled

Agent Port: 161

Agent ses. time: 03:00 min

Agent ID: 0

Read Community: DEVA9009

Write Community: DEVA9009

Manager IP: 192.168.001.001 Test

Manager Port: 162

SNMP MIB File: Download

▲ - These settings require reboot.

Save Save & Reboot

Network

The network addresses could be set manually (static IP) or automatically via a DHCP Server. To set static **IP**, **Netmask**, **Gateway** and **DNS** addresses, the **DHCP** should be disabled. In order for the built-in DHCP client to be activated, the function should be enabled. When the DHCP client is activated, all assigned values will be shown in the relevant fields on the “Status Screen”. If due to any reason, the DHCP procedure cannot be completed, DB9009-RX will use Auto IP and will generate an IP Address.

E-mail

Enter the desired alarm recipients in **E-mail 1** and/or **E-mail 2** fields. Fill in your e-mail account settings: **Sender**, **Username** and **Password**, **Server**, **Server Port** and **Connection Type**. If you experience difficulties in the set-up, or would like to use DEVA account for sending of alarm email notifications, press the [DEVA] button option, and complete the recipient emails (E-mail 1 and E-mail 2) only. The other fields must be left blank, otherwise the email notification option will not be working. Event though using the DEVA account eases the set-up process, we recommend user account to be used for sending of email notifications, and the DEVA account for test purposes. When using DEVA account, please note that the stable 24/7 connection depends on the mail service provider and cannot be guaranteed. We recommend you to use the [Test] button and generate a test e-mail, which upon success will be delivered to the specified **E-mail 1** and/or **E-mail 2**. Example

of Test E-mail Message:

DB9009-RX Test Message.

Please do not reply to this e-mail.

HTTP Server

Enable/Disable the HTTP Server. Specify the Server Port and Session Timeout.

FTP Server

Enable/Disable the FTP Server. Specify the Command and Data Ports to be used. For information on how the connection between the DB9009-RX and an FTP Client should be configured, please refer to [“Download files via FTP” on page 60](#).

SNMP Agent

Specify Agent ID, Agent Port, Read/Write Communities, Manager IP, Manager Port and AgentSession Time.

Agent – enables/disables SNMP Agent.

Agent ID – is used for identification of the device among others, when an SNMP notification is being sent. Once all needed settings are applied, use the Test button to generate a test notification, which upon success will be received by the SNMP Manager. Press the [Download] button to download the latest available DB9009-RX SNMP MIB file.

NOTE: The MIB file may vary from one firmware revision to another. Downloading this file from the device, guarantees that you have the proper MIB file.

GPIO

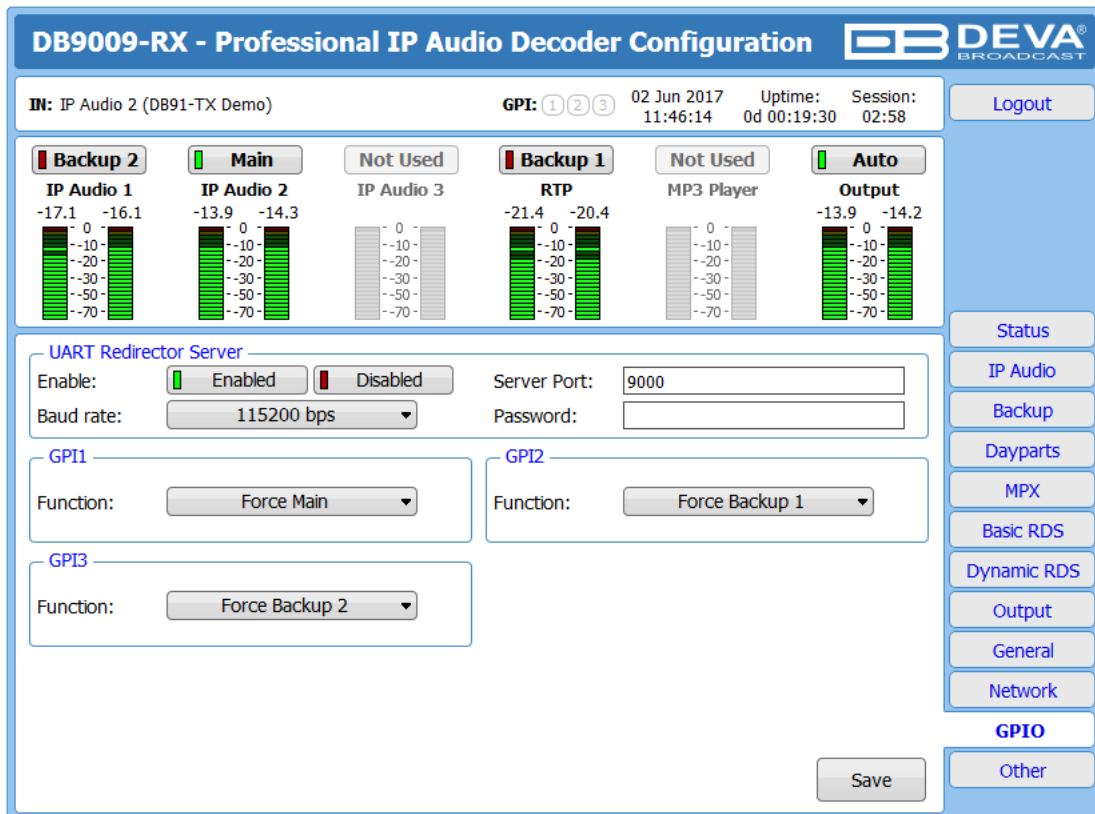

The screenshot displays the configuration page for the DB9009-RX Professional IP Audio Decoder. At the top, it shows the system name 'DB9009-RX - Professional IP Audio Decoder Configuration' and the DEVA BROADCAST logo. Below this, there's a header with 'IN: IP Audio 2 (DB91-TX Demo)', 'GPI: ① ② ③', and system statistics like '02 Jun 2017 11:46:14', 'Uptime: 0d 00:19:30', and 'Session: 02:58'. A 'Logout' button is on the right.

The main area features several audio level meters: 'Backup 2' (IP Audio 1: -17.1, -16.1; IP Audio 2: -13.9, -14.3), 'Main' (IP Audio 2: -13.9, -14.3), 'Not Used' (IP Audio 3), 'Backup 1' (RTP: -21.4, -20.4), 'Not Used' (MP3 Player), and 'Auto' (Output: -13.9, -14.2). Each meter has a scale from 0 to -70 dB.

Below the meters is the 'UART Redirector Server' section with 'Enable' (Enabled), 'Baud rate' (115200 bps), 'Server Port' (9000), and 'Password' fields. The 'GPIO' section includes three rows: 'GPI1' (Function: Force Main), 'GPI2' (Function: Force Backup 1), and 'GPI3' (Function: Force Backup 2). A 'Save' button is at the bottom right.

On the right side, there's a vertical menu with buttons for 'Status', 'IP Audio', 'Backup', 'Dayparts', 'MPX', 'Basic RDS', 'Dynamic RDS', 'Output', 'General', 'Network', 'GPIO' (highlighted), and 'Other'.

The general purpose outputs/inputs settings are applied through this page.

UART Redirector Server - DB9009-RX also acts as Ethernet to RS-232 redirector. You can connect any RS-232 compatible equipment to DB9009-RX and communicate with it over the Internet. The option can be either [Enabled] or [Disabled].

Baud rate – Select baud rate of the RS-232 COM Port. The external equipment must be configured to the same baud rate.

Port – a field where TCP port of the Ethernet to RS-232 redirector is to be entered. This is the TCP port used to communicate with any external device connected to the RS-232 COM Port.

Password – Password for the RS-232 server. These are the first symbols that must be sent to authenticate to the Ethernet to RS-232 redirector, otherwise the connection is dropped. If left blank NO security is used. Default value is blank (empty).

GPI1 to GPI3 – Each can be assigned to force either the Main or Backup 1 and Backup 2 audio sources.

OTHER

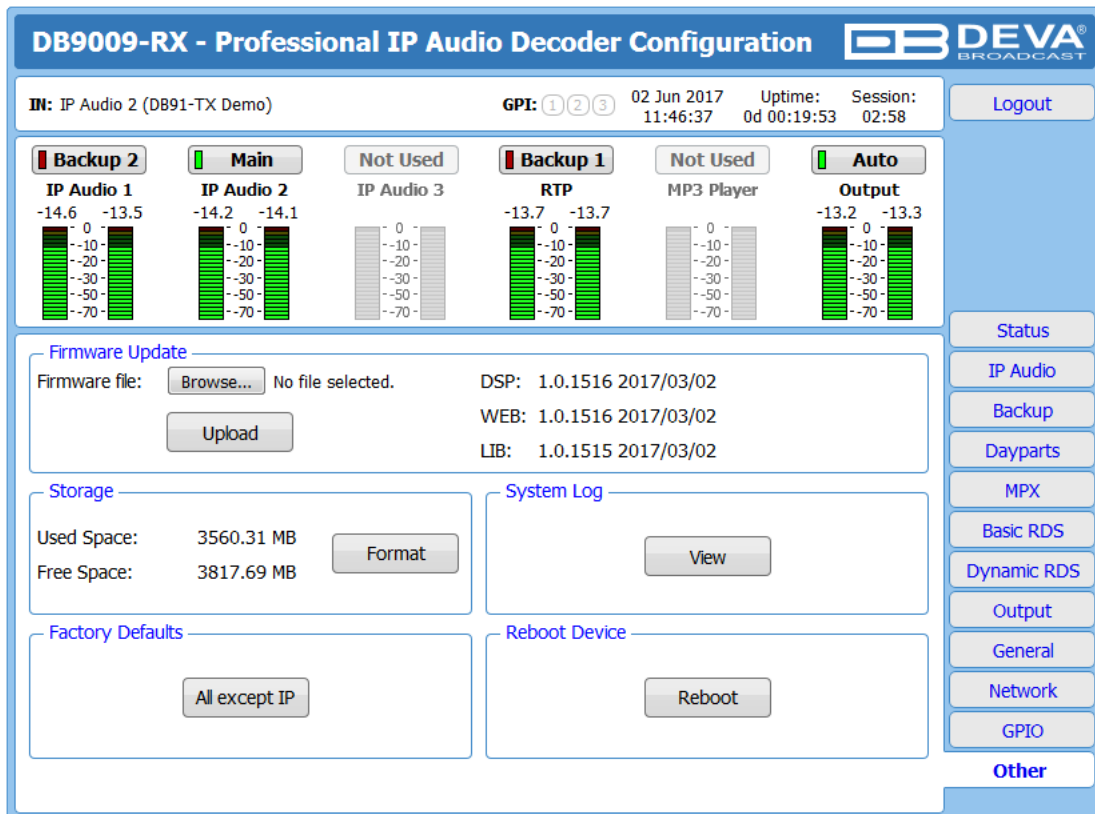

Firmware Update

To update the device firmware, press [Browse] and select the new firmware file. After having pressed the [Upload] button, a dialog window will appear. Confirm the firmware update and wait for the process to complete.

IMPORTANT NOTE: If the firmware is downloaded from www.devabroadcast.com, the file must be unzipped prior to the upgrade.

Storage

Information about the device storage space is found in this section. The internal storage could be deleted by pressing the [Format] button.

System Log

By pressing the [View] button, a window with the following options will appear:



Pressing the [Clear] button will delete all recorded in the system log information.

Pressing the [Reload] button will update the displayed information.

Factory Defaults

[All except IP] – all settings except for the Network settings (IP addresses) will be deleted.

To restore DB9009-RX to its factory defaults press the button. A new window will appear - confirm that you want to restore the factory defaults and wait for the process to be completed. On completion of the process, the settings should have the proper default values.

Reboot Device

To reboot the DB9009-RX, press the [Reboot] button. A dialog warning window will appear. Confirm that you want to reboot the device and wait for the process to be completed.

WARRANTY TERMS AND CONDITIONS

I. TERMS OF SALE: DEVA Broadcast Ltd. products are sold with an understanding of “full satisfaction”; that is, full credit or refund will be issued for products sold as new if returned to the point of purchase within 30 days following their receipt, provided that they are returned complete and in an “as received” condition.

II. CONDITIONS OF WARRANTY: The following terms apply unless amended in writing by DEVA Broadcast Ltd.

A. The Warranty Registration Card supplied with this product must be completed and returned to DEVA Broadcast Ltd. within 10 days of delivery.

B. This Warranty applies only to products sold “as new.” It is extended only to the original end-user and may not be transferred or assigned without prior written approval by DEVA Broadcast Ltd.

C. This Warranty does not apply to damage caused by improper mains settings and/or power supply.

D. This Warranty does not apply to damage caused by misuse, abuse, accident or neglect. This Warranty is voided by unauthorized attempts at repair or modification, or if the serial identification label has been removed or altered.

III. TERMS OF WARRANTY: DEVA Broadcast Ltd. products are warranted to be free from defects in materials and workmanship.

A. Any discrepancies noted within TWO YEARS of the date of delivery will be repaired free of charge, or the equipment will be replaced with a new or remanufactured product at DEVA Broadcast Ltd. option.

B. Parts and labor for factory repair required after the two-year Warranty period will be billed at prevailing prices and rates.

IV. RETURNING GOODS FOR FACTORY REPAIR:

A. Equipment will not be accepted for Warranty or other repair without a Return Authorization (RA) number issued by DEVA Broadcast Ltd. prior to its return. An RA number may be obtained by calling the factory. The number should be prominently marked on the outside of the shipping carton.

B. Equipment must be shipped prepaid to DEVA Broadcast Ltd.. Shipping charges will be reimbursed for valid Warranty claims. Damage sustained as a result of improper packing for return to the factory is not covered under terms of the Warranty and may occasion additional charges.

PRODUCT REGISTRATION CARD

- All fields are required, or warranty registration is invalid and void

Your Company Name _____

Contact _____

Address Line 1 _____

Address Line 2 _____

City _____

State/Province _____ ZIP/Postal Code _____

Country _____

E-mail _____ Phone _____ Fax _____

Which DEVA Broadcast Ltd. product did you purchase? _____

Product Serial # _____

Purchase date ____ / ____ / ____

Installation date ____ / ____ / ____

Your signature*

*Signing this warranty registration form you are stating that all the information provided to DEVA Broadcast Ltd. are truth and correct. DEVA Broadcast Ltd. declines any responsibility for the provided information that could result in an immediate loss of warranty for the above specified product(s).

Privacy statement: DEVA Broadcast Ltd. will not share the personal information you provide on this card with any other parties.

APPENDIX A

RDS: EUROPE VS AMERICA

The European Broadcasting Union (EBU) and its member countries originated the concept of “Radio Data” transmission. The European RDS specification, CENELEC Standard EN50067, was first published in 1984. It was revised in 1986, 1990, 1991 and 1992.

European RDS has grown in use following initial adoption of the Standard. RDS is nearly universal throughout Europe; it is almost impossible to find a European FM broadcasting station that does not carry a radio data subcarrier.

The popularity of RDS in Europe is very much in contrast with initial reluctance on the part of US broadcasters to embrace this technology. This can be ascribed to material differences in broadcasting practices.

Almost without exception, FM broadcasting in the United States is ‘detached’ and independent - each station originates its own programming. America’s National Public Radio might be considered as an exception, though for most of the broadcast day even NPR stations originate, or at least schedule, their own programs.

Most of European broadcasting is similar to the concept of network radio that was common in the US prior to the 1950s. In Europe, a central program originator may have many transmitting facilities of modest power situated throughout the country, at several different frequencies to blanket a designated service area. The European disposition, toward lower-power transmitters can be found on the “local radio” level, as well.

The European concept of a service area equates to the US broadcaster’s market. The subtle difference between these designations further characterizes broadcasting practices and ethics. RDS benefits the European broadcaster through almost an altruistic endeavor to be of service to his listeners. The US broadcaster is marketing his programming and is primarily interested in how he can create additional revenue from RDS.

THE RDS SYSTEM

RDS is a digital data channel, transmitted as a low-level subcarrier above the range of the composite stereo program signal in the FM baseband. The data transmission (baud) rate is comparatively low, yet it is quite robust because of data redundancy and effective error correction.

It is not within the scope of this Manual to cover the details of RDS subcarrier coding and modulation. For this, the reader is directed to the Specification appropriate to his location either the CENELEC EN50067 Specification for Europe or the United States NRSC Specification. Since the Manual will deal with specific implication of RDS implemented with the DB9009-RX, it is assumed that the user is familiar with the RDS concept.

APPENDIX B

HOW SHOULD I CONFIGURE THE CONNECTION BETWEEN MY DEVA DEVICE AND AN FTP CLIENT?

In order for a connection to be established the following setting should be applied:

1. FTP Server Settings

The built-in FTP Server has four important parameters that should be configured: Command Port, Data Port, User name and Password. These parameters are to be used in the FTP client's connection configuration. Further information on how to change the FTP Server's settings and their respective default values can be found in the device's User manual.

WE RECOMMEND the usage of FileZilla (<https://filezilla-project.org>). This is a widespread open source software distributed free of charge, hence available for downloading from the Internet.

NOTE: The FTP Server can manage only one connection at a time. The FTP Server works in Passive mode. Hence, the FTP Client should also be set in passive mode.

2. IP Router and Port Translation Settings

If the connection to the device is made through a Network address translation (NAT) router or firewall, the port forwarding feature of the router should be configured. The port forwarding is usually set in the firewall section of the router's menu. As each router has different port forwarding procedure, we recommend you to refer to its complete manual. To allow proper data flow through the router, the FTP Command and FTP Data ports should be open.

NOTE: The FTP port numbers to be used in the port forwarding feature configuration can be found in the device.

3. Example of FTP Client (FileZilla) Settings

In some cases, FileZilla's "Quick connect" feature is not able to connect with the DEVA unit. That is why we recommend the device to be assigned in the program manually.

Enter the FTP Client and go to: **File > Site manager > New Site**. A dialog box requiring obligatory information about the device will appear. Fill in the needed information and press "OK".

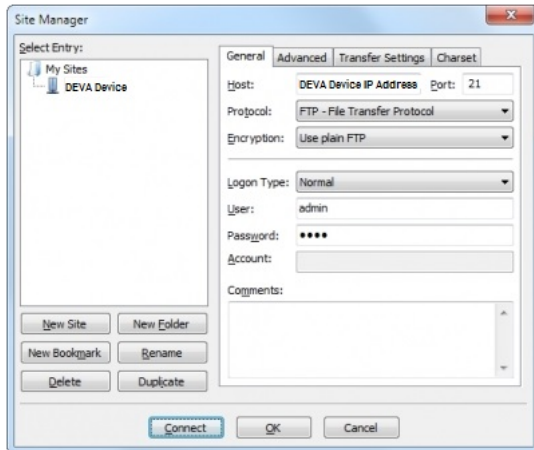

Select "Transfer Settings" sub-menu and apply the settings as shown below:

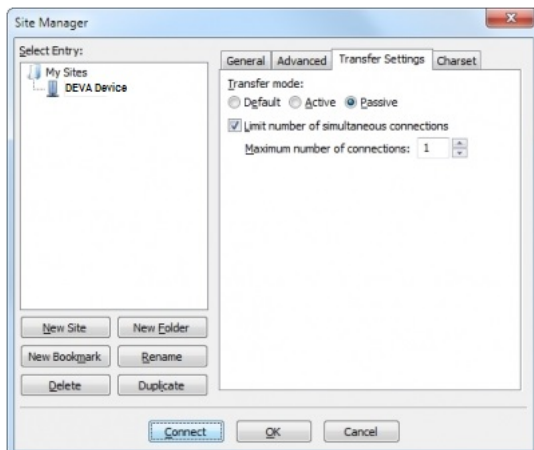

APPENDIX C.1

PTY Code Description Used in RBDS Mode – North America

PTY	Short Name	Description
1	News	News reports, either local or network in origin.
2	Information	Programming that is intended to impart advice.
3	Sports	Sports reporting, commentary, and/or live event coverage, either local or network in origin.
4	Talk	Call-in and/or interview talk shows either local or national in origin.
5	Rock	Album cuts.
6	Classic Rock	Rock oriented oldies, often mixed with hit oldies, from a decade or more ago.
7	Adult Hits	An up-tempo contemporary hits format with no hard rock and no rap.
8	Soft Rock	Album cuts with a generally soft tempo.
9	Top 40	Current hits, often encompassing a variety of rock styles.
10	Country	Country music, including contemporary and traditional styles.
11	Oldies	Popular music, usually rock, with 80% or greater non-current music.
12	Soft	A cross between adult hits and classical, primarily non-current softrock originals.
13	Nostalgia	Big-band music.
14	Jazz	Mostly instrumental, includes both traditional jazz and more modern “smooth jazz.”
15	Classical	Mostly instrumentals, usually orchestral or symphonic music.
16	Rhythm and Blues	A wide range of musical styles, often called “urban contemporary.”
17	Soft R and B	Rhythm and blues with a generally soft tempo.
18	Foreign Language	Any programming format in a language other than English.
19	Religious Music	Music programming with religious lyrics.
20	Religious Talk	Call-in shows, interview programs, etc. with a religious theme.
21	Personality	A radio show where the on-air personality is the main attraction.
22	Public	Programming that is supported by listeners and/or corporate sponsors instead of advertising.
23	College	Programming produced by a college or university radio station.
24	Spanish Talk	Call-in shows, interview programs, etc. in the Spanish language
25	Spanish Music	Music programming in the Spanish language
26	Hip-Hop	Popular music incorporating elements of rap, rhythm-and-blues, funk, and soul
27-28	Unassigned	
29	Weather	Weather forecasts or bulletins that are non-emergency in nature.
30	Emergency Test	Broadcast when testing emergency broadcast equipment or receivers. Not intended for searching or dynamic switching for consumer receivers. Receivers may, if desired, display “TEST” or “Emergency Test”.
31	Emergency	Emergency announcement made under exceptional circumstances to give warning of events causing danger of a general nature. Not to be used for searching - only used in a receiver for dynamic switching.

NOTE: These definitions can differ slightly between various language versions.

APPENDIX C.2

PTY Code Description Used in RDS Mode – Europe, Asia

PTY	Short Name	Description
1	News	Short accounts of facts, events and publicly expressed views, reportage and actuality.
2	Current affairs	Topical program expanding or enlarging upon the news, generally in different presentation style or concept, including debate, or analysis.
3	Information	Program the purpose of which is to impart advice in the widest sense.
4	Sport	Program concerned with any aspect of sport.
5	Education	Program intended primarily to educate, of which the formal element is fundamental.
6	Drama	All radio plays and serials.
7	Culture	Programs concerned with any aspect of national or regional culture.
8	Science	Programs about the natural sciences and technology.
9	Varied	Used for mainly speech-based programs usually of light-entertainment nature, not covered by other categories. Examples include: quizzes, games, personality interviews.
10	Pop	Commercial music, which would generally be considered to be of current popular appeal, often featuring in current or recent record sales charts.
11	Rock	Contemporary modern music, usually written and performed by young musicians.
12	Easy Listening	Current contemporary music considered to be “easy-listening”, as opposed to Pop, Rock or Classical, or one of the specialized music styles, Jazz, Folk or Country. Music in this category is often but not always, vocal, and usually of short duration.
13	Light classics	Classical Musical for general, rather than specialist appreciation. Examples of music in this category are instrumental music, and vocal or choral works.
14	Serious classics	Performances of major orchestral works, symphonies, chamber music etc., and including Grand Opera.
15	Other music	Musical styles not fitting into any of the other categories. Particularly used for specialist music of which Rhythm & Blues and Reggae are examples.
16	Weather	Weather reports and forecasts and Meteorological information.
17	Finance	Stock Market reports, commerce, trading etc.
18	Children’s programs	For programs targeted at a young audience, primarily for entertainment and interest, rather than where the objective is to educate.
19	Social Affairs	Programs about people and things that influence them individually or in groups. Includes: sociology, history, geography, psychology and society.
20	Religion	Any aspect of beliefs and faiths, involving a God or Gods, the nature of existence and ethics.
21	Phone In	Involving members of the public expressing their views either by phone or at a public forum.
22	Travel	Features and programs concerned with travel to near and far destinations, package tours and travel ideas and opportunities. Not for use for Announcements about problems, delays, or roadworks affecting immediate travel where TP/TA should be used.
23	Leisure	Programs concerned with recreational activities in which the listener might participate. Examples include, Gardening, Fishing, Antique collecting, Cooking, Food & Wine etc.
24	Jazz Music	Polyphonic, syncopated music characterized by improvisation.
25	Country Music	Songs which originate from, or continue the musical tradition of the American Southern States. Characterized by a straightforward melody and narrative story line.
26	National Music	Current Popular Music of the Nation or Region in that country’s language, as opposed to International ‘Pop’ which is usually US or UK inspired and in English.
27	Oldies Music	Music from the so-called “golden age” of popular music.
28	Folk Music	Music which has its roots in the musical culture of a particular nation, usually played on acoustic instruments. The narrative or story may be based on historical events or people.
29	Documentary	Program concerned with factual matters, presented in an investigative style.
30	Alarm Test	Broadcast when testing emergency broadcast equipment or receivers. Not intended for searching or dynamic switching for consumer receivers.. Receivers may, if desired, display “TEST” or “Alarm Test”.
31	Alarm	Emergency announcement made under exceptional circumstances to give warning of events causing danger of a general nature. Not to be used for searching - only used in a receiver for dynamic switching.