

▶ KH 120 A

ACTIVE NEAR-FIELD LOUDSPEAKER

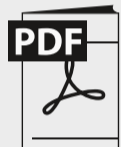

- Quick Guide
- Kurzanleitung
- Guide rapide
- Guida rapida
- Guía de inicio rápido
- Guia rápido
- Beknopte handleiding
- Krótka instrukcja obsługi
- Snabbguide
- Kort vejledning
- Pikaohje
- Γρήγορος οδηγός
- Kısa kılavuz
- Краткая инструкция
- 简要说明
- 快速使用指南
- クイックガイド
- 요약 안내서



Instruction manual | Bedienungsanleitung | Notice d'emploi | Istruzioni per l'uso | Instrucciones de manejo | Manual de instruções | Gebruiksaanwijzing | Instrukcja obsługi | Bruksanvisning | Betjeningsvejledning | Käyttöohje | Οδηγίες λειτουργίας | Kullanım kılavuzu | Инструкция по эксплуатации | 使用说明书 | 使用説明書 | 取扱説明書 | 사용 설명서 |

[www.neumann.com](http://www.neumann.com) | KH 120

GEORG NEUMANN GMBH · LEIPZIGER STR. 112 · 10117 BERLIN · GERMANY  
TEL +49 (0)30 / 41 77 24 -0 · FAX -50 · HEADOFFICE@NEUMANN.COM · WWW.NEUMANN.COM

PUBL. 12/18 - 581302/A02

Acoustics	
-3 dB free field frequency response	52 Hz to 21 kHz, ±3 dB
Pass band free field frequency response	54 Hz to 20 kHz, ±2 dB
Self-generated noise (with input gain set to 100 dB for 0 dBu)	<20 dB(A) at 10 cm
Total harmonic distortion < 0.5 % at 95 dB SPL at 1 m	>100 Hz
Max. SPL in full space / calc. in half space at 3 % THD at 1 m, averaged between 100 Hz and 6 kHz	105.1 dB SPL / 111.1 dB SPL
Bass capability: Max. SPL in half space with 3 % THD at 1 m, averaged between 50 Hz and 100 Hz	104.8 dB SPL
Max. short term SPL with IEC-weighted noise (IEC 60268-5) at 1 m, in typical listening conditions	107 dB(C) SPL
Max. short term SPL with music material at 2.3 m, in typical listening conditions (pair)	97 dB(C) SPL (full range) 104 dB(C) SPL (with subwoofer)
Max. long term SPL with pink noise at 2.3 m, in typical listening conditions (single/pair)	88/93 dB(C) SPL (full range) 89/94 dB(C) SPL (with subwoofer)

Electronics	
Woofer amplifier, continuous (peak) output power	50 W (80 W), THD and noise < 0.1 % with deactivated limiter
Tweeter amplifier, continuous (peak) output power	50 W (80 W), THD and noise < 0.1 % with deactivated limiter
Controller design	analog, active
Crossover frequency; crossover slope	2.0 kHz; 24 dB/oct., 4th order
ACOUSTICAL CONTROLS switches	BASS: 0, -2.5, -5, -7.5 dB LOW-MID: 0, -1.5, -3, -4.5 dB TREBLE: +1, 0, -1, -2 dB

Analog input	
Input type	XLR, electronically balanced
Input gain control (sensitivity)	0 dB to -15 dB
OUTPUT LEVEL switch	94, 100, 108, 114 dB SPL
Maximum input level	24 dBu (ANALOG mode) 18 dBu (ANALOG DELAYED mode)

Product properties	
Power supply	100 to 240 V-, 50/60 Hz
Power consumption (idle)	20 W
Power consumption (full output AC)	200 W
Dimensions (H x W x D)	277 x 182 x 220 mm (107/8" x 71/8" x 85/8")
Weight	6.4 kg (14 lbs 2 oz)
Drivers – woofer, tweeter	magnetically shielded – 130 mm (5.25"), 25 mm (1")
Threaded inserts for Neumann mounting hardware	2 x M8 on rear panel with depth 15 mm (5/8")
Cabinet surface finish, Color	painted aluminium, Anthracite (RAL 7021) or White (9016) or other RAL color

A complete list of specifications can be found on the product page at [www.neumann.com](http://www.neumann.com).

Block diagram

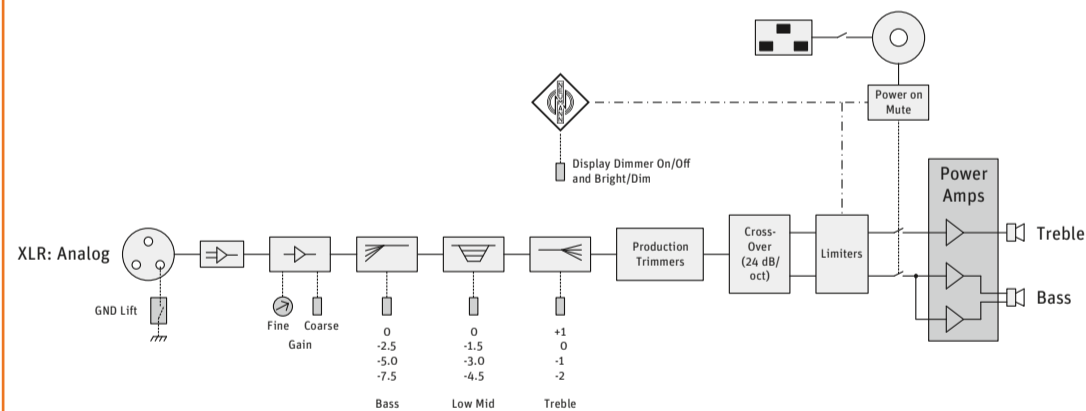

Installation angles

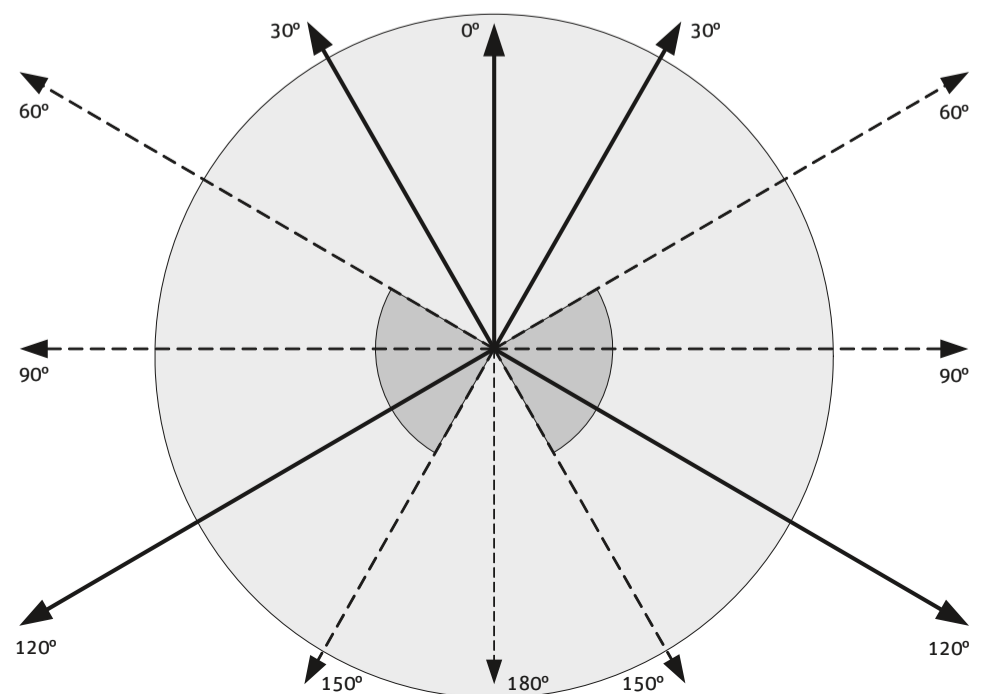

**Acoustical controls**

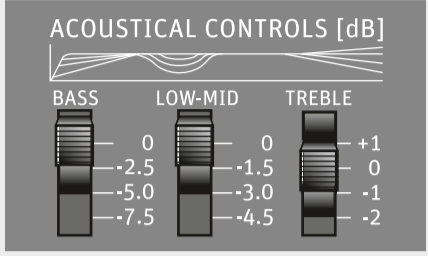

Against a wall

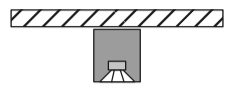

Solid: Bass = -5 dB  
Soft: Bass = -2.5 dB

In a corner

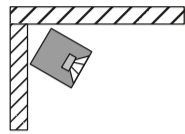

Bass = -7.5 dB  
Low-Mid = -1.5 dB

Near a desktop

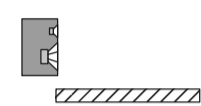

Small: Low-Mid = -1.5 dB  
Large: Low-Mid = -3 dB

Free standing

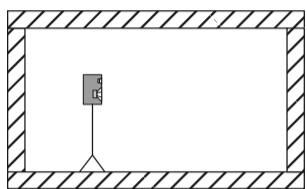

Live: Treble = -1 dB  
Bass = -2.5 dB  
Dead: All 0 dB

**Output level**

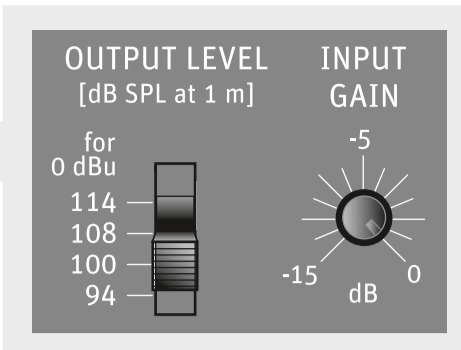

**Acoustical axis**

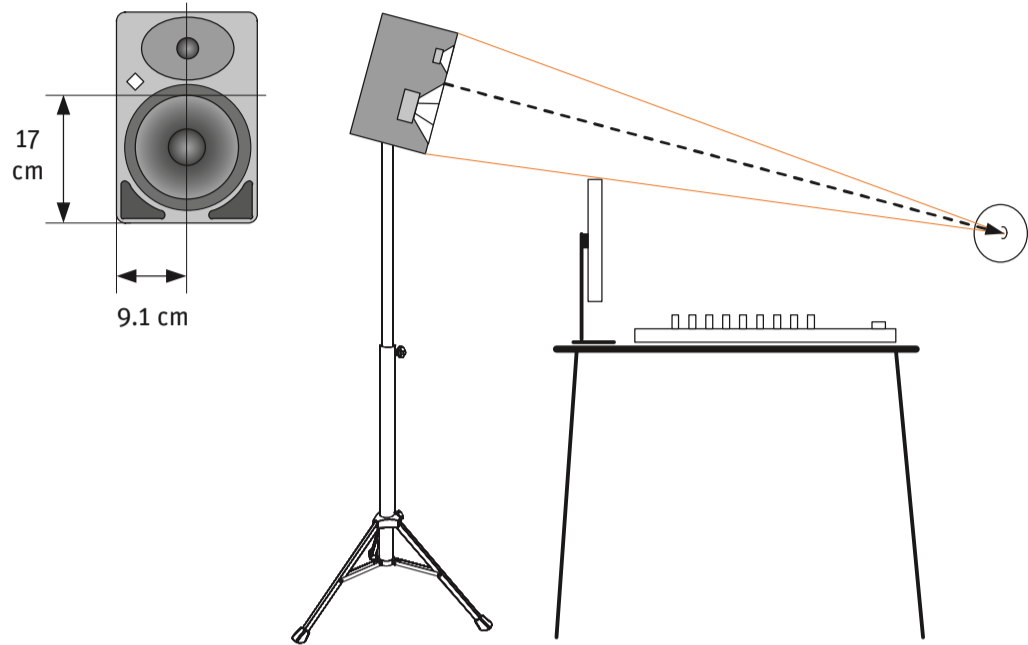

A detailed instruction manual can be found at: | Eine ausführliche Bedienungsanleitung finden Sie unter: | Vous trouverez une notice d'emploi détaillé sur : | Le istruzioni per l'uso dettagliate sono disponibili su: | Encontrará unas instrucciones de manejo detalladas en: | Consulte o manual de instruções detalhado em: | Een uitvoerige gebruiksaanwijzing staat onder: | Szczegółowa instrukcja obsługi jest dostępna na: | En utförlig bruksanvisning kan hämtas på: | Du kan finde en udførlig betjeningsvejledning på: | Yksityiskohtainen käyttöohje on saatavissa kohdasta: | Οι αναλυτικές οδηγίες λειτουργίας διατίθενται: | Ayrıntılı bir kullanım kılavuzu için bkz: | Подробную инструкцию по эксплуатации можно найти здесь: | 获取详细的使用说明书请访问: | 若要取得詳細的使用說明書, 請造訪: | 詳しい取扱説明書は以下でご覧ください: | 상세 사용 설명서는 다음 주소에 있습니다.

[www.neumann.com](http://www.neumann.com) | KH 120

**Power**

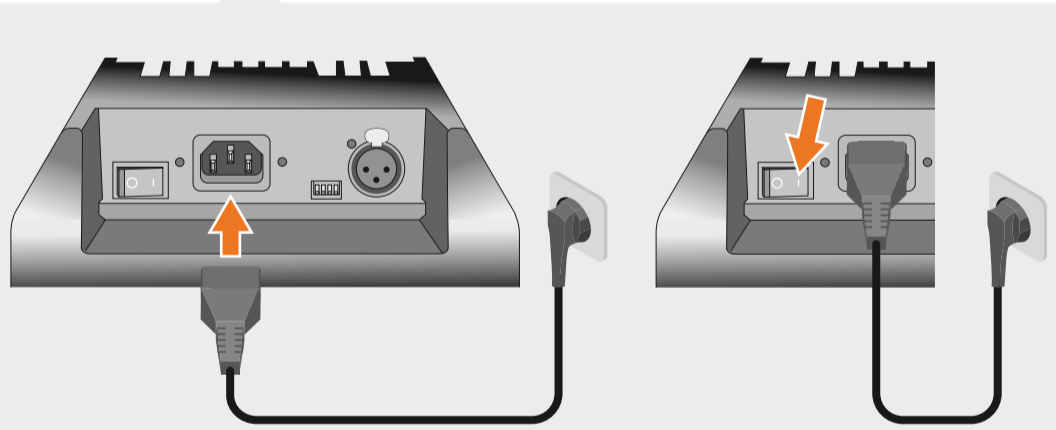
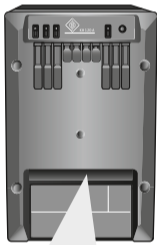

**DIP switches**

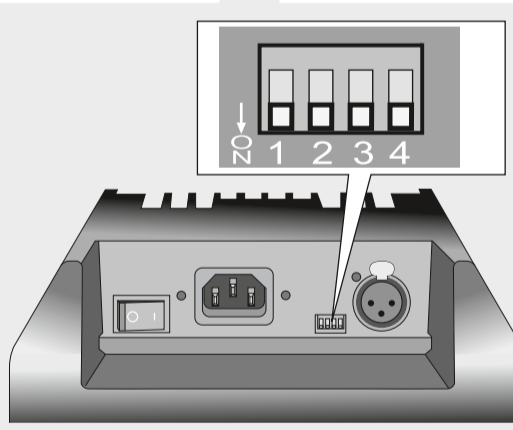
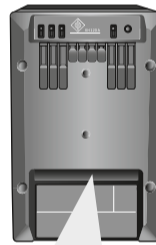

- [1] Switches the Neumann logo on/off
- [2] Dims the Neumann logo
- [3] No function
- [4] Connects/disconnects ground lift

**Analog audio**

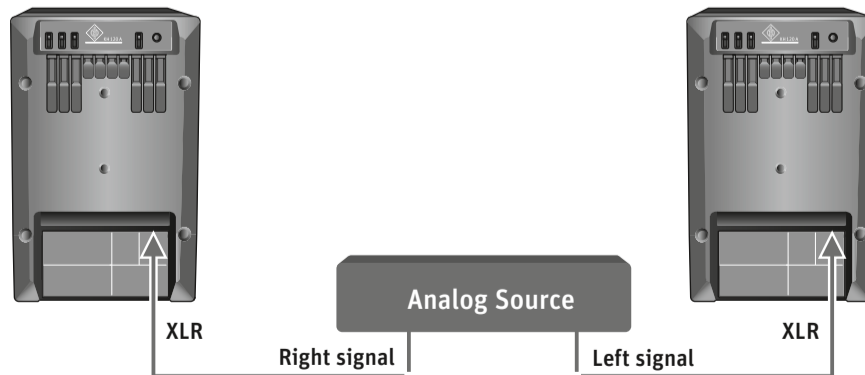
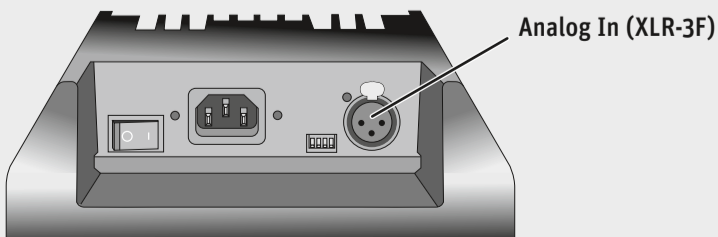
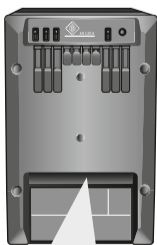

**RCA to XLR adapter**

