



01

Check the included items

As soon as you open the package, check to see that all items are included. If anything is missing, please contact your dealer.

* This package does not include a kick pedal. Use with a commercially available kick pedal.

MDS-Compact

* For the items included with the stand (MDS-Compact), refer to the owner's manual when checking that all items are included.



Hi-hat control pedal (FD-9)



Kick pad (KD-10)



Cymbal pad for hi-hat (CY-5)

V-Cymbal for crash (CY-12C-T)
V-Cymbal for ride (CY-14R-T)

V-Pad for snare (PDX-12)



V-Pad for tom (PDX-8 x 3)



Drum sound module (TD) (TD-17)



Connection cable (special for TD)



AC adaptor

- Setup Guide (this document)
- Owner's manual set
- Drum key

02

Assemble the stand

* The tip of the mount is sharp. Handle it with care.

* When setting up or storing the stand, be careful not to pinch the fingers you use to handle the stand.

Assembly procedure

Assemble the stand (MDS-Compact) as type A (for hi-hat) following the procedure described in the owner's manual.

Loosen this hand knob, and rotate the mount holder (L) 90 degrees in the direction of the arrow.

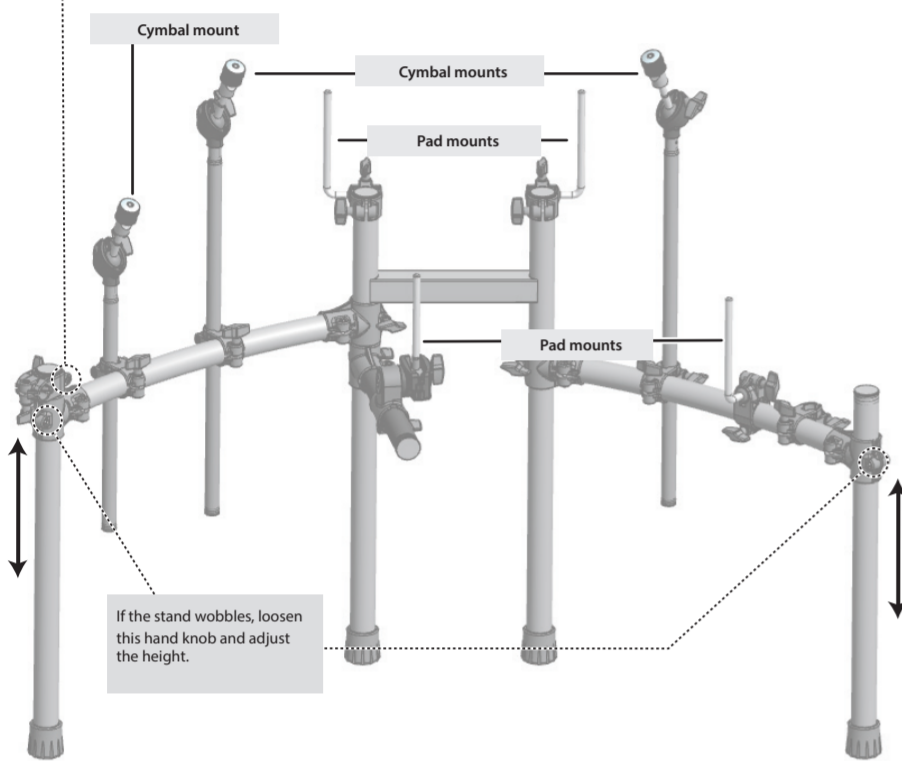
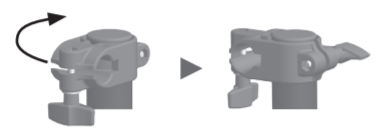

* For reasons of safety, do not spread the stand wider than 1.2 meters (47 inches).

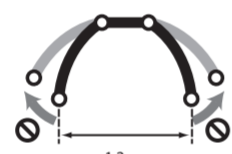

03

Attach the parts

Attach the hi-hat (CY-5)

Roland logo on the farther side



Tighten the cymbal nut enough to prevent the pad from wobbling when you strike it. Use the cymbal nut and felt washer that are included with the stand.

Attach the crash cymbal (CY-12C-T) and ride cymbal (CY-14R-T)

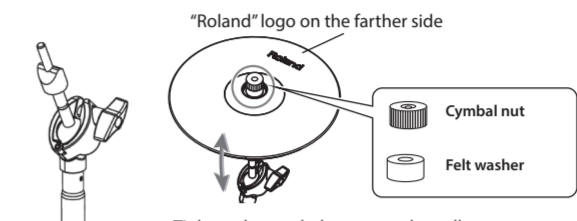

Tighten the cymbal nut enough to allow an appropriate amount of sway. Use the cymbal nut and felt washer that are included with the stand.

Attach the TD

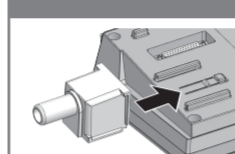

1. Align the protrusions of the sound module mount with the rails of the TD, and slide it in until you hear it click.

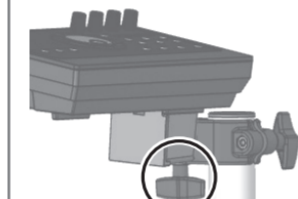

2. Loosen the hand knob of the mount holder, and insert the sound module mount.

3. Adjust the angle of the TD, and then tighten the hand knob.

Place the hi-hat control pedal (FD-9)

If you're using this unit on a V-Drums mat, on a noise eater (NE-10), or on carpet, extending the anchor bolts will secure the unit in place, making it easier for you to perform.

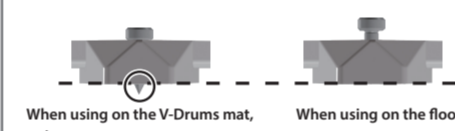

When using on the V-Drums mat, noise eater, or carpet

When using on the floor

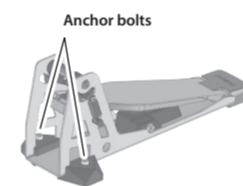

Anchor bolts

* The tips of the anchor bolts are sharp. Handle with care.
* When used on flooring, the anchor bolts may damage the floor.

Adjusting the position of the cymbal

Adjust the height of the rod so that the highest point of the cymbal is less than 1.2 meters.

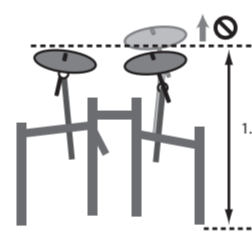

Attach the cymbal so that its center does not extend toward the back beyond the pipes of the stand (the pipes at the back of the stand).

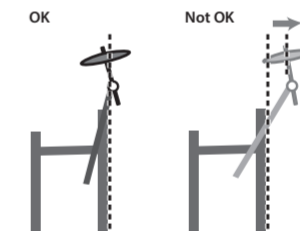

OK

Not OK

Attach the kick pedal (KD-10)

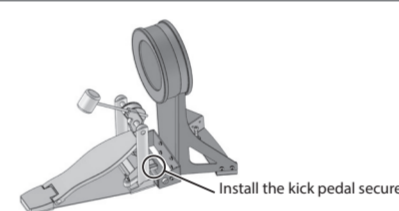

Install the kick pedal securely.

Attach the snare (PDX-12) and toms (PDX-8)

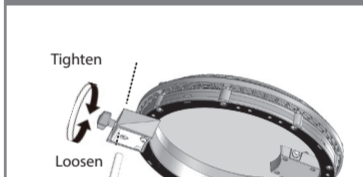

Tighten

Loosen

Rod

Tighten

Loosen

Rod

04

Connect the pads to TD

Connection procedure

1. Connect the cable to TD as shown in the illustration.

Insert the connector all the way, then turn the knobs to fasten it securely.

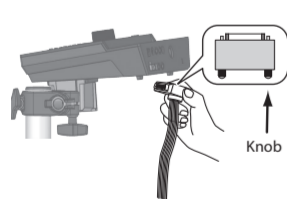

Knob

2. Labels indicating the pad to be connected are attached to the cable. Connect the cable to the OUTPUT jack of each pad as shown in the illustration.



* Insert the plug firmly, making sure it's all the way in.

* Fasten the cables so that they will not obstruct your playing; use cable clips and cable ties.
Make sure to wrap the cable ties around the pipes.

As seen from the back

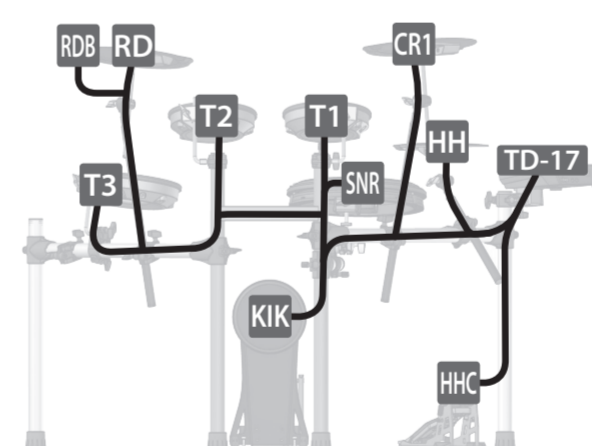

05

Connect the AC adaptor and speakers

Connect the AC adaptor, speakers, or headphones as described in the owner's manual of the TD.

* To prevent malfunction and equipment failure, always turn down the volume, and turn off all the units before making any connections.

For a left-handed setup

The setup described in this guide is for right-handed players. To set up for a left-handed player, reattach the components as follows.

- Exchange curved pipes (L) and (R), and straight pipes (L) and (R), left-for-right.
- Attach holder (C) and the snare pipe to the right side.
- Attach the mount holder (L) to the curved pipe (L).
- Exchange the pads and cymbals with their attachment mounts left-for-right.
- Exchange the TD with its sound module mount left-for-right.

After exchanging the curved pipes, attach the holders so that the marks on the pipes are visible through the gaps of the holders.



Remove the caps, remove holder (C) and the snare pipe, and reattach them to the right side.

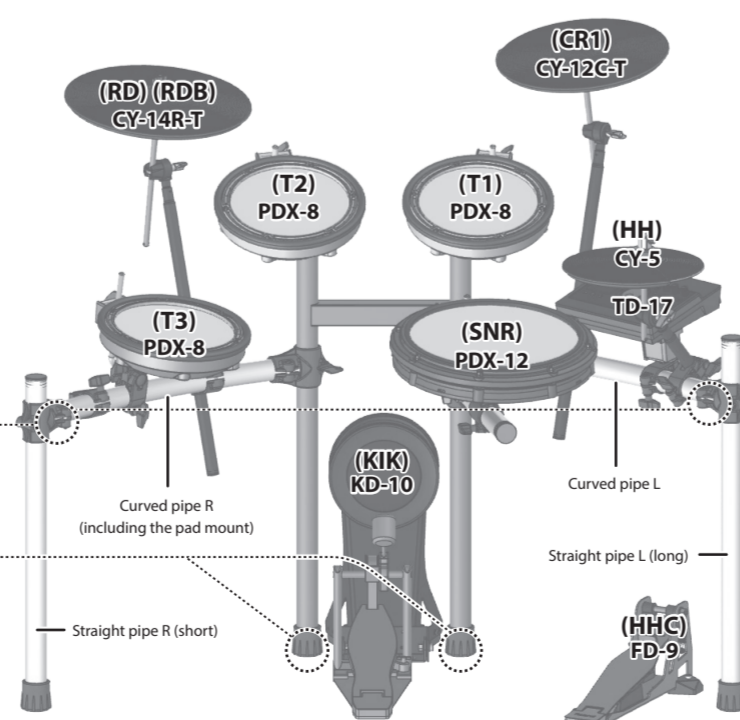

Connect the cables as shown in the illustration.

As seen from the back

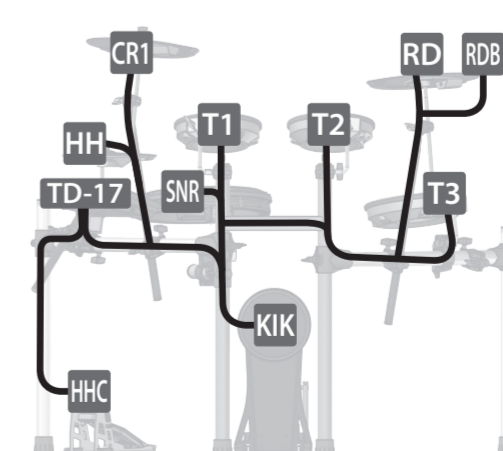

This completes assembly and connections.

■ When you've finished making connections, turn on the power as described in the TD-17/17-L Owner's Manual, and verify that you can hear sound.

Detailed explanation of each part

KD-10 (Kick)

01 Attach the kick pedal.

Position the beater so that it strikes the center of the head, then secure the kick pedal and KD-10 firmly in place.

* A variety of commercially available beaters can be used, including felt, plastic, or wood types. However if a felt beater is used, the felt may leave marks on the striking surface.

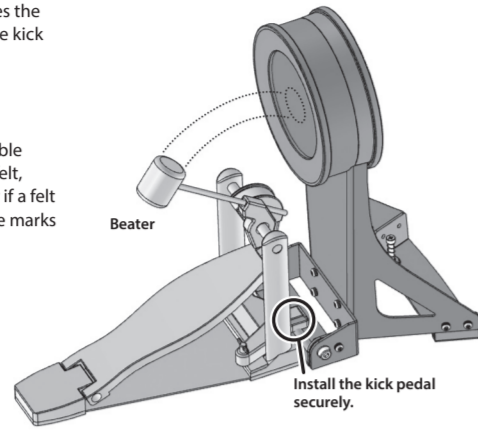

When Using a Twin Pedal

Position the two beaters equally apart from the center of the pad as shown in the figure at left. If one of the beaters is further away from the center than the other, the sound from the further beater will be lower in volume, or will not sound as desired.

If you're using twin pedals, the sensitivity will be lower than when a single pedal is used. Raise the sensitivity on the sound module. For details, refer to the TD's owner's manual.

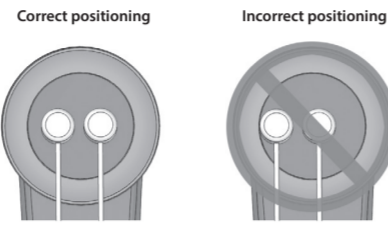

02 Step on the kick pedal and make sure that it's properly attached and in a stable position.

Check to make sure that the base of the KD-10 and the kick pedal both make contact with the floor.

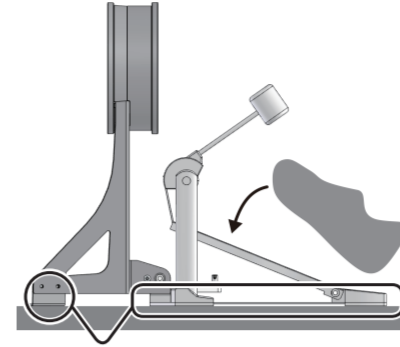

Check to be sure they're making contact with the floor

NOTE

- * Attach the KD-10 and the kick pedal securely.
- * Take care not to pinch your fingers.
- * Depending on how you're using the unit, the bolts that attach the pedal to the plate could become loose, causing the pedal to rattle during performance. In such cases, use commercially available tools to tighten the bolts.

03 Adjusting the Anchor Bolts.

If you're using this unit on a V-Drums mat, on a noise eater (NE-10), or on carpet, extending the anchor bolts will secure the unit in place.

However, if that's not enough to keep the KD-10 in a fixed position, you can adjust things so that the tips of the anchor bolts protrude through the base. That should keep it in place and make it easier for you to play.

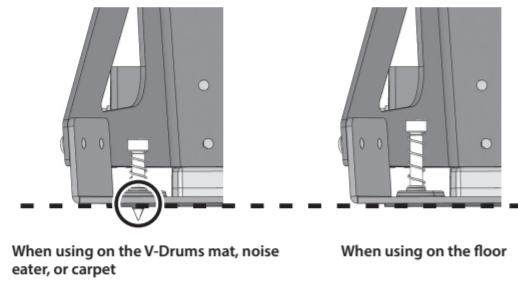

NOTE

- * When used on flooring, the anchor bolts may damage the floor. Adjust the anchor bolts correctly.
- * The tips of the anchor bolts are sharp. Handle with care.

Component names

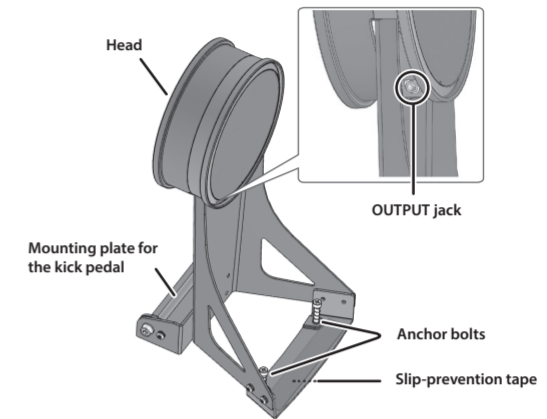

FD-9 (Hi-hat control pedal)

Adjusting the feeling

You can lighten the feeling by removing either the left or the right spring. Take care not to pinch your finger when removing or installing a spring.

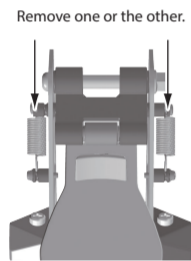

1. Detach lower hook.

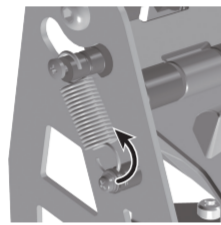

2. Detach upper hook.

To reinstall the spring, attach the upper hook first.

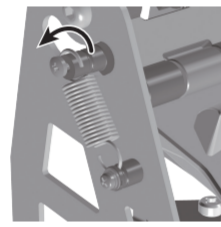

Component names

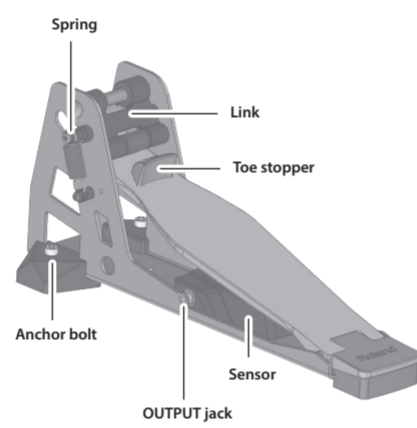

CY-5 (Hi-hat)

CY-12C-T (Crash)

CY-14R-T (Ride)

CY-5 component names

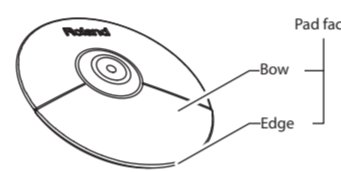

CY-12C-T component names



CY-14R-T component names

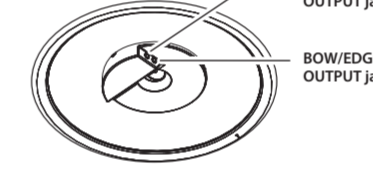
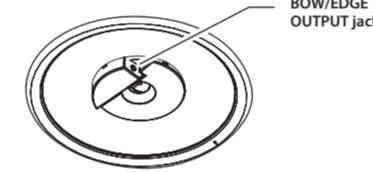
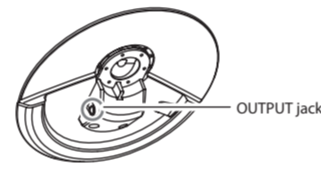

NOTE

Continuous playing may cause dis-coloration of the pad, but this will not affect the Pad's function.

Fixing the cables (CY-14R-T/CY-12C-T)

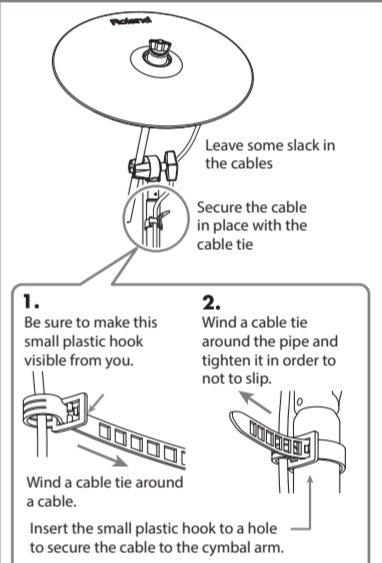

PDX-12 (Snare)

Component names

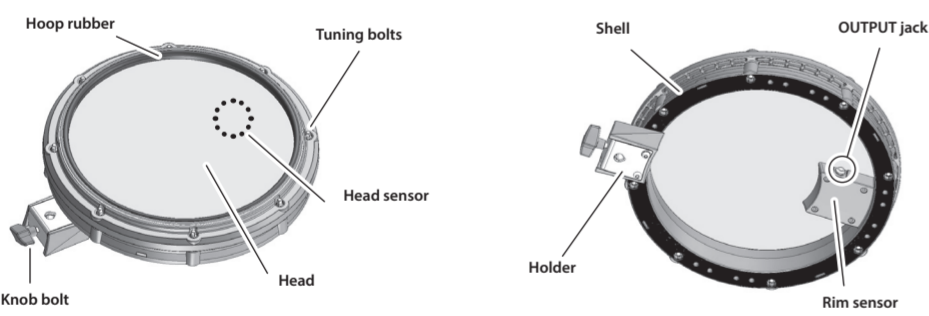

Adjusting the head tension

When the unit is shipped from the factory, this is adjusted fairly loosely. Before use, adjust the head to a fairly high tension.

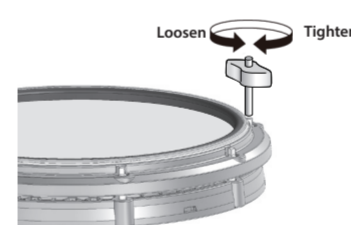

1. Adjust each tuning bolt a little at a time, moving in order from one side to the opposite side as shown in the illustration.
 2. Fine-tune the adjustment while continuing to check the pad feel and response.
- * Do not firmly tighten a single tuning bolt by itself. Doing so will make it impossible to tension the head evenly, and will cause malfunctions.

PDX-8 (Tom)

Component names

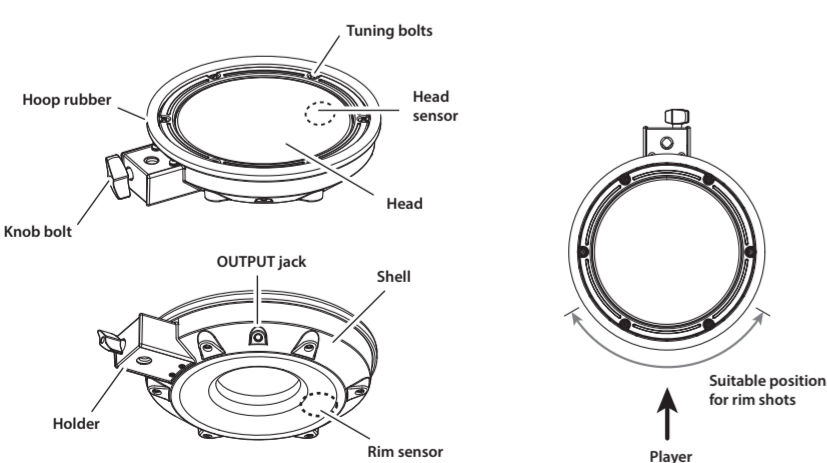

NOTE

Be sure to adjust the head tension of the pad before use.

Adjusting the head tension



1. Adjust each tuning bolt a little at a time, moving in order from one side to the opposite side as shown in the illustration. The appropriate amount of tension is one that will provide approximately the same striking response as on an acoustic drum.

2. Use the drum key to adjust the tension as needed.